

 **GREE**  
AIR CONDITIONER



**GREE ELECTRIC APPLIANCES, INC. OF ZHUHAI**

Add: West Jinji Rd, Qianshan, Zhuhai, Guangdong, China 519070  
Tel: (+86-756) 852 2218 Fax: (+86-756) 866 9426  
Email: gree@gree.com.cn Http://www.gree.com

**HONG KONG GREE ELECTRIC APPLIANCES SALES LIMITED**

Add: Unit 2612, 26/F, Mira Place Tower A, 132 Nathan Road, Tsimshatsui, Kowloon, Hong Kong  
Tel: (852) 3165 8898 Fax: (852) 3165 1029

**Note:**  
Gree is committed to continuously improving its products to ensure the highest quality and reliability standards, and to meet local regulations and market requirements.

All features and specifications are subject to change without prior notice.

All images provided in this catalogue are used for illustration purposes only.  
Copyright© Gree Electric Appliances, Inc. of Zhuhai. All rights reserved.

**GC-2004-08**



Distributor information



**CAC**  
NORTH AMERICA  
T1/R410A/60Hz  
**2020**

MADE IN CHINA  
LOVED BY THE WORLD



## ABOUT GREE

Gree Electric Appliances, Inc. of Zhuhai was founded in 1991 and it was listed on the Shenzhen Stock Exchange in November 1996. At the beginning, Gree was only a company that assembled residential air conditioners. Now it has grown into a diversified technological global industrial group, whose brands including GREE, KINGHOME and TOSOT that has expanded its business to air conditioners, home appliances, high-end equipment and communication equipment. Gree products are sold widely to more than 200 countries and regions.

Thanks to 300 million users' choices, Gree products are widely sold in more than 200 countries and regions. Today Gree's annual production capacity of RAC and CAC is more than 60 million and 6 million sets respectively.

Action makes the future and innovation makes achievement. Looking forward, Gree will press ahead with its business philosophy of passion, innovation and realization. We aim to build a century air conditioning enterprise and create a better life for humankind.

## CONTENTS

05	Air-Cooled GMV5
21	Water-cooled GMV
27	GMV5 Solar
33	Ultra Heat GMV
37	Indoor Units
67	Control System



## Parts



### Golden fin condenser

Anti-corrosive performance of golden fins is 3 times better than normal fins.



### Inner groove copper

Special thickened inner groove copper tube enhances heat exchanging performance.

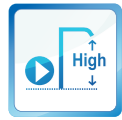

### Built-in drain pump

The drain pump can pump the condensation to a high level. It facilitates condensation draining from the indoor unit and makes the installation of the indoor unit easier.



### Washable filter

Filters are easy to remove and install. You can use a dirt collector or water to clear away the dust.



### Quality motor

High-quality motor, stable operation and low noise.



### Slave and master wired controller

One indoor unit can be connected with two wired controllers to realize controlling of the same indoor unit from different control points.



### Long connection pipe design

The total length of the connection pipe reaches 1000m, which greatly improves the engineering flexibility of the unit.

## High Efficiency & Energy Saving



### High efficiency

The air conditioner is designed for high energy efficiency and power-saving.



### Intelligent defrosting

It performs defrosting intelligently when necessary, thus improving heating efficiency and saving energy.



### Energy-saving function

When this function is activated, the temperature setting is only within a limited range to save energy.



### All DC inverter technology

All motors adopt DC inverter technology, which greatly improves energy efficiency.

## Comfortable & Healthy



### Vertical swing

Air discharge louver can be moved vertically and automatically to efficiently distribute air and temperature throughout the room.



### Horizontal swing

Air discharge louver can automatically move horizontally for efficient air and temperature distribution throughout the room.

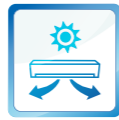

### Anti-cold function

The indoor unit will not blow in the winter if the air is not warm enough.



### Turbo function

To run with strong power and make you feel comfortable (cool or warm) quickly.



### Fresh air supply ventilation

The unit can introduce a certain percentage of fresh air to satisfy the fresh air requirement.



### Comfortable sleeping mode

When setting the "Sleep Mode", you can adjust the set temperature and indoor noise to a more comfortable level.



### Quiet function

The unit is ensured to operate with the lowest noise by ultra-low fan speed and auto adjustment according to the system parameters.

## Convenience



### Memory function

Unit is able to remember the operations before power failure and automatically returns to those operations when power is restored.



### Compact design

The unit is designed with a smaller dimension, which is easy for installation and transportation, cost-saving.



### Easier maintainability

The unit is designed to be easier for maintenance and component replacement.



### Auto addressing technology

The new generation of indoor unit applies auto addressing technology, which greatly reduces project debugging time and error rate.

## Reliability



### Auto clean

When the unit is turned off, the indoor fan will keep running in low speed for a moment to dry the inner components and parts, in order to prevent mildew and keep users healthy.



### Self-diagnosis

Malfunction codes are shown on the display panel for fast and easy troubleshooting when a malfunction occurs.



### Low voltage startup

The unit is able to safely start when the voltage is below standard.



### Low-temperature heating

When the ambient temperature is below -4°F, the unit can start and operate normally. The heating capacity remains the same.



### Modular operating

Several units can operate together as modules, so that capacity output control is more precise, and also higher reliability.



### Comprehensive protection

The unit is designed with various protection functions to ensure reliability.

## Versatility



### High ESP

The external static pressure range is wider, which ensures longer delivery distance to provide powerful cooling.



### Wide operation range

The unit can operate in a wide range, greatly reducing the ambient temperature limitation.



### Multi fan speed

The fan can operate with multi-speeds and satisfy different airflow volume requirements.



### Modular structure

A high-efficiency compressor presents a reliable performance.

## Control



### 24-hour timer

The unit can be set to turn on or turn off at any time in a day. (The timing interval is 5min.)



### 7-day programmable thermostat

The unit can be set to start heating or cooling anytime on a daily or weekly basis.



### °C/°F switch

Under off status, press MODE and "-" buttons simultaneously to switch / F.



### Clock display

Time is shown on the remote controller.



### Child lock

It avoids child's wrong operation on the remote controller.



### Key-card control

The Key-card control function is specially designed for the hotel rooms. By removing the key-card, the unit can automatically switch to standby status.



### Centralized control

Start, stop and adjust the air conditioner remotely.



### Long-distance monitoring

Long-distance monitoring enables the unit to be controlled and monitored from a long distance.



### Shield function

Remotely control the indoor unit and shield the functions of the wired controller which include ON/OFF, temp or mode setting, energy-saving function, etc.



### Human engineering operation

Adopts the technologies of auto addressing, non-polar communication and auto debugging, which improves project efficiency.

# AIR-COOLED GMV5

GMV5

GMV5 Mini

GMV5 Heat Recovery

GMV MTAC





# GMV5

Gree GMV5 All DC Inverter VRF adopts high-efficient DC inverter compressor and DC inverter fan motor. The unit can be combined modularly from 6 tons to 30 tons. Maximum capacity can reach up to 360 kBtu/h.



6 Ton



208/203V: 8/10/12 Ton  
460V: 8/10 Ton



14 Ton

All DC inverter technology	Energy saving function	Quiet function	Human engineering operation	High ESP	Wide operation range	Modular operating	Long connection pipe design	Comprehensive protection

- Outdoor unit quiet mode.
- High energy efficiency with a high-performance compressor; Long connection pipe design with the maximum length of 3280 3/4 feet.
- Auto switch of module status every 8hrs, which greatly improves the reliability of a complete unit.
- 4 levels of static pressure for option with the maximum of 0.33In.W.G.



Max. piping length (m(ft.))	GMV5
Total piping length	1000(3280-3/4)
Actual piping length	165(541-1/4)
Equivalent piping length	190(623-1/4)
Height difference between indoor units	30(98-1/2)
Height difference between ODU and IDU (ODU is located above the IDU)	90(295-1/4)
Height difference between ODU and IDU (IDU is located above the ODU)	90(295-1/4)
Piping length from first indoor branch to the farthest IDU	40(131-1/4)

Item	Rated operating condition (temperature)				Operation range (temperature)
	Outdoor condition		Indoor condition		
	DB(°F/ )	WB(°F/ )	DB(°F/ )	WB(°F/ )	GMV5
Cooling	95/35	75/23.9	80/26.7	67/19.4	23~125.6/-5~52
Heating	47/8.3	43/6.1	70/21.1	60/15.6	-4~75.2/-20~24

## ODU Combination Lineup

### 208/230V

Model	GMV-72WM/B-F(U) (6Ton)	GMV-96WM/B-F(U) (8Ton)	GMV-120WM/B-F(U) (10Ton)	GMV-144WM/B1-F(U) (12Ton)	GMV-168WM/B1-F(U) (14Ton)
GMV-72WM/B-F(U) (6Ton)	●				
GMV-96WM/B-F(U) (8Ton)		●			
GMV-120WM/B-F(U) (10Ton)			●		
GMV-144WM/B1-F(U) (12Ton)				●	
GMV-168WM/B1-F(U) (14Ton)					●
GMV-144WM/B-F(U) (12Ton)	●●				
GMV-168WM/B-F(U) (14Ton)	●	●			
GMV-192WM/B-F(U) (16Ton)		●●			
GMV-216WM/B-F(U) (18Ton)		●	●		
GMV-240WM/B-F(U) (20Ton)			●●		
GMV-264WM/B-F(U) (22Ton)	●	●●			
GMV-288WM/B-F(U) (24Ton)		●●●			
GMV-312WM/B-F(U) (26Ton)		●●	●		
GMV-336WM/B-F(U) (28Ton)		●	●●		
GMV-360WM/B-F(U) (30Ton)			●●●		

### 460V

Model	GMV-72WM/B-U(U) (6Ton)	GMV-96WM/B-U(U) (8Ton)	GMV-120WM/B-U(U) (10Ton)
GMV-72WM/B-U(U) (6Ton)	●		
GMV-96WM/B-U(U) (8Ton)		●	
GMV-120WM/B-U(U) (10Ton)			●
GMV-144WM/B-U(U) (12Ton)	●●		
GMV-168WM/B-U(U) (14Ton)	●	●	
GMV-192WM/B-U(U) (16Ton)		●●	
GMV-216WM/B-U(U) (18Ton)		●	●
GMV-240WM/B-U(U) (20Ton)			●●
GMV-264WM/B-U(U) (22Ton)	●	●●	
GMV-288WM/B-U(U) (24Ton)		●●●	
GMV-312WM/B-U(U) (26Ton)		●●	●
GMV-336WM/B-U(U) (28Ton)		●	●●
GMV-360WM/B-U(U) (30Ton)			●●●

## Specifications

### 208/230V

Model		GMV-72WM/B-F(U)	GMV-96WM/B-F(U)	GMV-120WM/B-F(U)	GMV-144WM/B1-F(U)	GMV-168WM/B1-F(U)
Capacity range	Ton	6	8	10	12	14
Rated capacity*	Cooling	Btu/h 69,000	Btu/h 92,000	Btu/h 114,000	Btu/h 138,000	Btu/h 150,000
	Heating	Btu/h 77,000	Btu/h 103,000	Btu/h 129,000	Btu/h 154,000	Btu/h 180,000
Air flow volume	CFM	6710	8240	8240	8240	9416
Power supply	V/Ph/Hz	208/230~3~60				
MCA	A	31	37	50	55	57
MOP	A	35	45	60	70	70
Maximum drive IDU NO.	unit	13	16	19	23	29
Refrigerant charge volume	lbs	14.33	24.91	25.79	25.79	25.79
Sound pressure level	dB(A)	60	61	63	64	65
Connecting pipe	Liquid	In. Φ3/8	Φ3/8	Φ1/2	Φ1/2	Φ5/8
	Gas	In. Φ3/4	Φ7/8	Φ1-1/8	Φ1-1/8	Φ1-1/8
	Oil balance	In. Φ3/8	Φ3/8	Φ3/8	Φ3/8	Φ3/8
Dimension (W×D×H)	Outline	In. 36-5/8×30-1/8×63-1/4	52-3/4×30-1/8×63-1/4	52-3/4×30-1/8×63-1/4	52-3/4×30-1/8×63-1/4	52-3/4×30-1/8×68-1/2
	Package	In. 39-3/4×33-1/8×69-7/8	55-7/8×33-1/8×69-7/8	55-7/8×33-1/8×69-7/8	55-7/8×33-1/8×69-7/8	55-7/8×33-1/8×75-1/4
Net weight/Gross weight	lbs	496/518	662/695	794/827	794/827	849/882
Loading quantity	40' GP	set	24	16	16	16
	40' HQ	set	24	16	16	16

\*Note: Rated capacity is certified under AHRI Standard 1230. Ratings are subject to change without notice. Current certified ratings are available at [www.ahridirectory.org](http://www.ahridirectory.org).

### 460V

Model		GMV-72WM/B-U(U)	GMV-96WM/B-U(U)	GMV-120WM/B-U(U)
Capacity range	Ton	6	8	10
Rated capacity*	Cooling	Btu/h 69,000	Btu/h 92,000	Btu/h 114,000
	Heating	Btu/h 77,000	Btu/h 103,000	Btu/h 129,000
Air flow volume	CFM	6710	8240	8240
Power supply	V/Ph/Hz	460~3~60		
MCA	A	15	18	25
MOP	A	20	25	30
Maximum drive IDU NO.	unit	13	16	19
Refrigerant charge volume	lbs	14.33	24.91	25.79
Sound pressure level	dB(A)	60	61	63
Connecting pipe	Liquid	In. Φ3/8	Φ3/8	Φ1/2
	Gas	In. Φ3/4	Φ7/8	Φ1-1/8
	Oil balance	In. Φ3/8	Φ3/8	Φ3/8
Dimension(W×D×H)	Outline	In. 36-5/8×30-1/8×63-1/4	52-3/4×30-1/8×63-1/4	52-3/4×30-1/8×63-1/4
	Package	In. 39-3/4×33-1/8×69-7/8	55-7/8×33-1/8×69-7/8	55-7/8×33-1/8×69-7/8
Net weight/Gross weight	lbs	503/524	672/705	794/827
Loading quantity	40' GP	set	24	16
	40' HQ	set	24	16

\*Note: Rated capacity is certified under AHRI Standard 1230. Ratings are subject to change without notice. Current certified ratings are available at [www.ahridirectory.org](http://www.ahridirectory.org).

## Specifications of ODU Combination

### 208/230V

Model	Power supply	Rated capacity*		Dimension(W×D×H)	Airflow volume	ESP	Sound pressure level	Operation sound pressure level at night	Connecting pipe diameter		Oil balance pipe	MCA	MOP	Weight
		Cooling	Heating						Liquid	Gas				
		V/Ph/Hz	Btu/h						Btu/h	In.				
GMV-144WM/B-F(U)	208/230~3~60	138,000	154,000	(36-5/8×30-1/8×63-1/4)×2	6710×2	0.33	62	48	Φ1/2	Φ1-1/8	Φ3/8	31+31	35+35	496×2
GMV-168WM/B-F(U)		160,000	180,000	(36-5/8×30-1/8×63-1/4)+(52-3/4×30-1/8×63-1/4)	6710+8240	0.33	63	48	Φ5/8	Φ1-1/8	Φ3/8	31+37	35+45	496+662
GMV-192WM/B-F(U)		184,000	206,000	(52-3/4×30-1/8×63-1/4)×2	8240×2	0.33	63	48	Φ5/8	Φ1-1/8	Φ3/8	37+37	45+45	662×2
GMV-216WM/B-F(U)		206,000	230,000	(52-3/4×30-1/8×63-1/4)×2	8240×2	0.33	65	48	Φ5/8	Φ1-1/8	Φ3/8	37+50	45+60	662+794
GMV-240WM/B-F(U)		228,000	256,000	(52-3/4×30-1/8×63-1/4)×2	8240×2	0.33	65	48	Φ5/8	Φ1-3/8	Φ3/8	50+50	60+60	794×2
GMV-264WM/B-F(U)		250,000	282,000	(36-5/8×30-1/8×63-1/4)+(52-3/4×30-1/8×63-1/4)×2	6710+8240×2	0.33	65	48	Φ3/4	Φ1-3/8	Φ3/8	31+37+37	35+45+45	496+662×2
GMV-288WM/B-F(U)		274,000	308,000	(52-3/4×30-1/8×63-1/4)×3	8240×3	0.33	65	48	Φ3/4	Φ1-3/8	Φ3/8	37+37+37	45+45+45	662×3
GMV-312WM/B-F(U)		296,000	334,000	(52-3/4×30-1/8×63-1/4)×3	8240×3	0.33	66	48	Φ3/4	Φ1-3/8	Φ3/8	37+37+50	45+45+60	662×2+794
GMV-336WM/B-F(U)		320,000	360,000	(52-3/4×30-1/8×63-1/4)×3	8240×3	0.33	67	48	Φ3/4	Φ1-3/8	Φ3/8	37+50+50	45+60+60	662+794×2
GMV-360WM/B-F(U)		342,000	384,000	(52-3/4×30-1/8×63-1/4)×3	8240×3	0.33	67	48	Φ3/4	Φ1-5/8	Φ3/8	50+50+50	60+60+60	794×3

\*Note: Rated capacity is certified under AHRI Standard 1230. Ratings are subject to change without notice. Current certified ratings are available at [www.ahridirectory.org](http://www.ahridirectory.org).

### 460V

Model	Power supply	Rated capacity*		Dimension(W×D×H)	Airflow volume	ESP	Sound pressure level	Operation sound pressure level at night	Connecting pipe diameter		Oil balance pipe	MCA	MOP	Weight
		Cooling	Heating						Liquid	Gas				
		V/Ph/Hz	Btu/h						Btu/h	In.				
GMV-144WM/B-U(U)	460~3~60	138,000	154,000	(36-5/8×30-1/8×63-1/4)×2	6710×2	0.33	62	48	Φ1/2	Φ1-1/8	Φ3/8	15+15	20+20	503×2
GMV-168WM/B-U(U)		160,000	180,000	(36-5/8×30-1/8×63-1/4)+(52-3/4×30-1/8×63-1/4)	6710+8240	0.33	63	48	Φ5/8	Φ1-1/8	Φ3/8	15+18	20+25	503+672
GMV-192WM/B-U(U)		184,000	206,000	(52-3/4×30-1/8×63-1/4)×2	8240×2	0.33	63	48	Φ5/8	Φ1-1/8	Φ3/8	18+18	25+25	672×2
GMV-216WM/B-U(U)		206,000	230,000	(52-3/4×30-1/8×63-1/4)×2	8240×2	0.33	65	48	Φ5/8	Φ1-1/8	Φ3/8	18+25	25+30	672+794
GMV-240WM/B-U(U)		228,000	256,000	(52-3/4×30-1/8×63-1/4)×2	8240×2	0.33	65	48	Φ5/8	Φ1-3/8	Φ3/8	25+25	30+30	794×2
GMV-264WM/B-U(U)		250,000	282,000	(36-5/8×30-1/8×63-1/4)+(52-3/4×30-1/8×63-1/4)×2	6710+8240×2	0.33	65	48	Φ3/4	Φ1-3/8	Φ3/8	15+18+18	20+25+25	503+672×2
GMV-288WM/B-U(U)		274,000	308,000	(52-3/4×30-1/8×63-1/4)×3	8240×3	0.33	65	48	Φ3/4	Φ1-3/8	Φ3/8	18+18+18	25+25+25	672×3
GMV-312WM/B-U(U)		296,000	334,000	(52-3/4×30-1/8×63-1/4)×3	8240×3	0.33	66	48	Φ3/4	Φ1-3/8	Φ3/8	18+18+25	25+25+30	672×2+794
GMV-336WM/B-U(U)		320,000	360,000	(52-3/4×30-1/8×63-1/4)×3	8240×3	0.33	67	48	Φ3/4	Φ1-3/8	Φ3/8	18+25+25	25+30+30	672+794×2
GMV-360WM/B-U(U)		342,000	384,000	(52-3/4×30-1/8×63-1/4)×3	8240×3	0.33	67	48	Φ3/4	Φ1-5/8	Φ3/8	25+25+25	30+30+30	794×3

\*Note: Rated capacity is certified under AHRI Standard 1230. Ratings are subject to change without notice. Current certified ratings are available at [www.ahridirectory.org](http://www.ahridirectory.org).





# GMV5 Mini

Gree GMV5 mini All DC Inverter VRF adopts a high-efficient DC inverter compressor and DC inverter fan motor. The unit can be combined modularly from 2 tons to 5 tons.



- All DC inverter technology
- Energy saving function
- Quiet function
- Human engineering operation
- Wide operation range
- Modular operating
- Long connection pipe design
- Comprehensive protection

- Outdoor unit quiet mode.
- High energy efficiency with a high-performance compressor; Long connection pipe design with the a maximum length of 300 (984-1/4)feet.
- Auto switch of module status every 8hrs, which greatly improves the reliability of a complete unit.



Max. piping length (m(ft.))	GMV5 Mini(2/2.5Ton)	GMV5 Mini(3/4/5Ton)
Total piping length	250 (820)	300 (984)
Actual piping length	100 (328)	120 (394)
Equivalent piping length	120 (394)	150 (492)
Height difference between indoor units	10 (33)	15 (49)
Height difference between ODU and IDU (ODU is located above the IDU)	30 (98)	50 (164)
Height difference between ODU and IDU (IDU is located above the ODU)	30 (98)	40 (131)
Piping length from first indoor branch to the farthest IDU	40 (131)	40 (131)

Item	Nominal operating condition (temperature)				Operation range (temperature)
	Outdoor condition		Indoor condition		Outdoor condition DB(°F/ )
	DB(°F/ )	WB(°F/ )	DB(°F/ )	WB(°F/ )	GMV5Mini
Cooling	95/35	75/23.9	80/26.7	67/19.4	23~118/-5~47.8
Heating	47/8.3	43/6.1	70/21.1	60/15.6	-4~81/-20~27.2

## Specifications

Model		GMV-36WL/A-T(U)	GMV-48WL/A-T(U)	GMV-60WL/A-T(U)	
Capacity range	Ton	3	4	5	
Capacity	Cooling	Btu/h	37,500	48,000	60,000
	Heating	Btu/h	42,000	54,000	64,000
Air flow volume	CFM	3531	3708	4590	
Power supply	V/Ph/Hz	208/230~1~60			
MCA	A	31	34	39.8	
MOP	A	35	45	60	
Maximum drive IDU NO.	unit	7	8	10	
Refrigerant charge volume	lbs	11.0	11.0	12.1	
Sound pressure level	dB(A)	57	58	63	
Connecting pipe	Liquid	In.	3/8	3/8	
	Gas	In.	5/8	5/8	3/4
Dimension (W×D×H)	Outline	In.	35-3/8×13-3/8×53	35-3/8×13-3/8×53	37×12-9/16×56-1/4
	Package	In.	39-1/4×18×59-1/16	39-1/4×18×59-1/16	40-5/8×17-1/16×62-1/4
Net weight/Gross weight	lbs	243/265	243/265	273/300	
Loading quantity	40' GP	set	57	57	57
	40' HQ	set	57	57	57

Model		GMV-24WL/C-T(U)	GMV-28WL/C-T(U)	GMV-36WL/C-T(U)	GMV-48WL/C-T(U)	GMV-60WL/C-T(U)	
Capacity range	Ton	2	2.5	3	4	5	
Capacity	Cooling	Btu/h	24000	28000	37500	48000	60000
	Heating	Btu/h	28000	32000	42000	54000	64000
Air flow volume	CFM	2295	2295	3531	3708	4708	
Power supply	V/Ph/Hz	208/230~1~60					
MCA	A	21	21	34	34	39.8	
MOP	A	25	30	35	45	60	
Maximum drive IDU NO.	unit	4	4	7	8	10	
Refrigerant charge volume	lbs	5.3	5.3	7.3	7.3	12.1	
Sound pressure level	dB(A)	57	57	57	58	63	
Connecting pipe	Liquid	In.	3/8	3/8	3/8	3/8	
	Gas	In.	5/8	5/8	5/8	5/8	3/4
Dimension (W×D×H)	Outline	In.	38-9/16×14-3/16×31-2/16	38-9/16×14-3/16×31-2/16	35-3/8×13-3/8×53	35-3/8×13-3/8×53	37×12-9/16×56-1/4
		In.	43-3/16×18-12/16×36-14/16	43-3/16×18-12/16×36-14/16	39-1/4×18×59-1/16	39-1/4×18×59-1/16	40-5/8×17-1/16×62-1/4
Net weight/Gross weight	lbs	176/199	176/199	239/261	239/261	269/296	
Loading quantity	40' GP	set	96	96	57	57	57
	40' HQ	set	96	96	57	57	57



# GMV5 Heat Recovery

GMV5 Heat Recovery System embodies the excellent features of GMV5(DC inverter technology, DC fan linkage control, precise control of capacity output, balancing control of refrigerant, original oil balancing technology with high-pressure chamber, high-efficiency output control, low-ambient temperature operation technology, sub cooling control technology, superheating technology, high adaptability for engineering, environmental refrigerant). Its energy efficiency is improved by 78% in comparison with conventional multi VRF.



- All DC inverter technology. All DC inverter compressor is used in this system. It can directly intake gas to reduce the loss of overheat and improve efficiency.
- 0.33In.W.G wide application location.
- Advanced control functions.
- Better reliability.
- Wide operation range: cooling: 23°F~125.6°F(-5°C~52°C); heating: -4°F~75.2°F(-20°C~24°C); cooling and heating:14°F~68°F(-10°C~20°C).



## ODU Combination Lineup

208/230V

Model	GMV-Q72WM/B-F(U) (6Ton)	GMV-Q96WM/B-F(U) (8Ton)	GMV-Q120WM/B-F(U) (10Ton)	GMV-Q144WM/B1-F(U) (12Ton)	GMV-Q168WM/B1-F(U) (14Ton)
GMV-Q72WM/B-F(U) (6Ton)	●				
GMV-Q96WM/B-F(U) (8Ton)		●			
GMV-Q120WM/B-F(U) (10Ton)			●		
GMV-Q144WM/B1-F(U) (12Ton)				●	
GMV-Q168WM/B1-F(U) (14Ton)					●
GMV-Q144WM/B-F(U) (12Ton)	● ●				
GMV-Q168WM/B-F(U) (14Ton)	●	●			
GMV-Q192WM/B-F(U) (16Ton)		● ●			
GMV-Q216WM/B-F(U) (18Ton)		●	●		
GMV-Q240WM/B-F(U) (20Ton)			● ●		
GMV-Q264WM/B-F(U) (22Ton)	●	● ●			
GMV-Q288WM/B-F(U) (24Ton)		● ● ●			
GMV-Q312WM/B-F(U) (26Ton)		● ●	●		
GMV-Q336WM/B-F(U) (28Ton)		●	● ●		
GMV-Q360WM/B-F(U) (30Ton)			● ● ●		



## ODU Combination Lineup

460V

Model	GMV-Q72WM/B-U(U) (6 Ton)	GMV-Q96WM/B-U(U) (8 Ton)	GMV-Q120WM/B-U(U) (10 Ton)
GMV-Q72WM/B-U(U) (6 Ton)	●		
GMV-Q96WM/B-U(U) (8 Ton)		●	
GMV-Q120WM/B-U(U) (10 Ton)			●
GMV-Q144WM/B-U(U) (12 Ton)	● ●		
GMV-Q168WM/B-U(U) (14 Ton)	●	●	
GMV-Q192WM/B-U(U) (16 Ton)		● ●	
GMV-Q216WM/B-U(U) (18 Ton)		●	●
GMV-Q240WM/B-U(U) (20 Ton)			● ●
GMV-Q264WM/B-U(U) (22 Ton)	●	● ●	
GMV-Q288WM/B-U(U) (24 Ton)		● ● ●	
GMV-Q312WM/B-U(U) (26 Ton)		● ●	●
GMV-Q336WM/B-U(U) (28 Ton)		●	● ●
GMV-Q360WM/B-U(U) (30 Ton)			● ● ●

## Specifications

208/230V

Model		GMV-Q72WM/B-F(U)	GMV-Q96WM/B-F(U)	GMV-Q120WM/B-F(U)	GMV-Q144WM/B1-F(U)	GMV-Q168WM/B1-F(U)	
Capacity range	Ton	6	8	10	12	14	
Rated capacity*	Cooling	Btu/h	69,000	92,000	114,000	136,000	150,000
	Heating	Btu/h	75,000	100,000	126,000	150,000	180,000
Air flow volume	CFM	8240	8240	8240	8240	9416	
Power supply	V/Ph/Hz	208/230~3~60					
MCA	A	32	37	50	55	57	
MOP	A	35	45	60	70	70	
Maximum drive IDU NO.	unit	13	16	19	23	29	
Refrigerant charge volume	lbs	21.16	24.69	25.79	25.79	25.79	
Sound pressure level	dB(A)	61	62	63	64	65	
Connecting pipe	Liquid	In.	Φ3/8	Φ3/8	Φ1/2	Φ1/2	Φ5/8
	Gas(Low pressure)	In.	Φ3/4	Φ7/8	Φ1-1/8	Φ1-1/8	Φ1-1/8
	Gas(High pressure)	In.	Φ5/8	Φ3/4	Φ7/8	Φ7/8	Φ7/8
Dimension (W×D×H)	Outline	In.	52-3/4×30-1/8×63-1/4	52-3/4×30-1/8×63-1/4	52-3/4×30-1/8×63-1/4	52-3/4×30-1/8×63-1/4	52-3/4×30-1/8×68-1/2
	Package	In.	55-7/8×33-1/8×69-7/8	55-7/8×33-1/8×69-7/8	55-7/8×33-1/8×69-7/8	55-7/8×33-1/8×69-7/8	55-7/8×33-1/8×75-1/4
Net weight/Gross weight	lbs	666/699	683/716	794/827	816/849	871/906	
Loading quantity	40' GP	set	16	16	16	16	16
	40' HQ	set	16	16	16	16	16

\*Note: Rated capacity is certified under AHRI Standard 1230. Ratings are subject to change without notice. Current certified ratings are available at [www.ahridirectory.org](http://www.ahridirectory.org).

460V

Model		GMV-Q72WM/B-U(U)	GMV-Q96WM/B-U(U)	GMV-Q120WM/B-U(U)	
Capacity range	Ton	6	8	10	
Rated capacity*	Cooling	Btu/h	69,000	92,000	114,000
	Heating	Btu/h	75,000	100,000	126,000
Air flow volume	CFM	8240	8240	8240	
Power supply	V/Ph/Hz	460~3~60			
MCA	A	15	18	25	
MOP	A	20	25	30	
Maximum drive IDU NO.	unit	13	16	19	
Refrigerant charge volume	lbs	21	25	25.79	
Sound pressure level	dB(A)	61	62	63	
Connecting pipe	Liquid	In.	Φ3/8	Φ3/8	Φ1/2
	Gas(Low pressure)	In.	Φ3/4	Φ7/8	Φ1-1/8
	Gas(High pressure)	In.	Φ5/8	Φ3/4	Φ7/8
Dimension (W×D×H)	Outline	In.	52-3/4×30-1/8×63-1/4	52-3/4×30-1/8×63-1/4	52-3/4×30-1/8×63-1/4
	Package	In.	55-7/8×33-1/8×69-7/8	55-7/8×33-1/8×69-7/8	55-7/8×33-1/8×69-7/8
Net weight/Gross weight	lbs	672/705	694/728	816/849	
Loading quantity	40' GP	set	16	16	16
	40' HQ	set	16	16	16

\*Note: Rated capacity is certified under AHRI Standard 1230. Ratings are subject to change without notice. Current certified ratings are available at [www.ahridirectory.org](http://www.ahridirectory.org).

Model		NCHS1B(U)	NCHS2B(U)	NCHS4B(U)	NCHS8B(U)
Max. Quantity of connecting IDU for mode exchanger	/	8	16	32	64
Max. branch quantity of connecting IDU	/	1	2	4	8
Max. quantity of connecting IDU for each branch	/	8	8	8	8
MAX.Capacity of connecting IDU for each branch	Btu/h	48,500	48,500	48,500	48,500
Total capacity of connecting IDU for each branch	Btu/h	48,500	96,000	154,000	232,000
Power supply	V/Ph/Hz	208/230~1~60			
Power consumption	W	8	20	32	64
Outdoor unit piping connection	Liquid	In.	Φ3/8	Φ3/8	Φ1/2
	Gas(Low pressure)	In.	Φ7/8	Φ7/8	Φ1-1/8
	Gas(High pressure)	In.	Φ5/8	Φ3/4	Φ7/8
Indoor unit piping connection	Liquid	In.	Φ3/8	Φ3/8	Φ3/8
	Gas	In.	Φ5/8	Φ5/8	Φ5/8

### Specifications of ODU Combination

#### 208/230V

Model	Power supply	Rated capacity*		Dimension(W×D×H)	Airflow volume	ESP	Sound pressure level	Operation sound pressure level at night	Connecting pipe diameter			MCA	MOP	Weight
		Cooling	Heating						Liquid	Gas(High pressure)	Gas(Low pressure)			
		Btu/h	Btu/h											
GMV-Q144WM/B-F(U)	208/230~3~60	134,000	150,000	(52-3/4x30-1/8x63-1/4)x2	8240x2	0.33	63	48	Φ1/2	Φ7/8	Φ1-1/8	32+32	35+35	666x2
GMV-Q168WM/B-F(U)		156,000	176,000	(52-3/4x30-1/8x63-1/4)x2	8240x2	0.33	64	48	Φ5/8	Φ7/8	Φ1-1/8	32+37	35+45	666+683
GMV-Q192WM/B-F(U)		184,000	200,000	(52-3/4x30-1/8x63-1/4)x2	8240x2	0.33	64	48	Φ5/8	Φ1-1/8	Φ1-1/8	37+37	45+45	683x2
GMV-Q216WM/B-F(U)		200,000	226,000	(52-3/4x30-1/8x63-1/4)x2	8240x2	0.33	65	48	Φ5/8	Φ1-1/8	Φ1-1/8	37+50	45+60	683+794
GMV-Q240WM/B-F(U)		224,000	240,000	(52-3/4x30-1/8x63-1/4)x2	8240x2	0.33	65	48	Φ5/8	Φ1-1/8	Φ1-3/8	50+50	60+60	794x2
GMV-Q264WM/B-F(U)		246,000	276,000	(52-3/4x30-1/8x63-1/4)x3	8240x3	0.33	65	48	Φ3/4	Φ1-1/8	Φ1-3/8	32+37+37	35+45+45	666+683x2
GMV-Q288WM/B-F(U)		268,000	294,000	(52-3/4x30-1/8x63-1/4)x3	8240x3	0.33	66	48	Φ3/4	Φ1-1/8	Φ1-3/8	37+37+37	45+45+45	683x3
GMV-Q312WM/B-F(U)		290,000	312,000	(52-3/4x30-1/8x63-1/4)x3	8240x3	0.33	66	48	Φ3/4	Φ1-1/8	Φ1-3/8	37+37+50	45+45+60	683x2+794
GMV-Q336WM/B-F(U)		312,000	320,000	(52-3/4x30-1/8x63-1/4)x3	8240x3	0.33	67	48	Φ3/4	Φ1-1/8	Φ1-3/8	37+50+50	45+60+60	683+794x2
GMV-Q360WM/B-F(U)		334,000	360,000	(52-3/4x30-1/8x63-1/4)x3	8240x3	0.33	67	48	Φ3/4	Φ1-3/8	Φ1-5/8	50+50+50	60+60+60	794x3

\*Note: Rated capacity is certified under AHRI Standard 1230. Ratings are subject to change without notice. Current certified ratings are available at [www.ahridirectory.org](http://www.ahridirectory.org).

### Specifications of ODU Combination

#### 460V

Model	Power supply	Rated capacity*		Dimension(W×D×H)	Airflow volume	ESP	Sound pressure level	Operation sound pressure level at night	Connecting pipe diameter			MCA	MOP	Weight
		Cooling	Heating						Liquid	Gas(High pressure)	Gas(Low pressure)			
		Btu/h	Btu/h											
GMV-Q144WM/B-U(U)	460~3~60	134,000	150,000	(52-3/4×30-1/8×63-1/4)×2	8240×2	0.33	63	48	Φ1/2	Φ7/8	Φ1-1/8	15+15	20+20	672×2
GMV-Q168WM/B-U(U)		156,000	176,000	(52-3/4×30-1/8×63-1/4)×2	8240×2	0.33	64	48	Φ5/8	Φ7/8	Φ1-1/8	15+18	20+25	672+694
GMV-Q192WM/B-U(U)		184,000	200,000	(52-3/4×30-1/8×63-1/4)×2	8240×2	0.33	64	48	Φ5/8	Φ1-1/8	Φ1-1/8	18+18	25+25	694×2
GMV-Q216WM/B-U(U)		200,000	226,000	(52-3/4×30-1/8×63-1/4)×2	8240×2	0.33	65	48	Φ5/8	Φ1-1/8	Φ1-1/8	18+25	25+30	694+816
GMV-Q240WM/B-U(U)		224,000	240,000	(52-3/4×30-1/8×63-1/4)×2	8240×2	0.33	65	48	Φ5/8	Φ1-1/8	Φ1-3/8	25+25	30+30	816×2
GMV-Q264WM/B-U(U)		246,000	276,000	(52-3/4×30-1/8×63-1/4)×3	8240×3	0.33	65	48	Φ3/4	Φ1-1/8	Φ1-3/8	15+18+18	20+25+25	672+694×2
GMV-Q288WM/B-U(U)		268,000	294,000	(52-3/4×30-1/8×63-1/4)×3	8240×3	0.33	66	48	Φ3/4	Φ1-1/8	Φ1-3/8	18+18+18	25+25+25	694×3
GMV-Q312WM/B-U(U)		290,000	312,000	(52-3/4×30-1/8×63-1/4)×3	8240×3	0.33	66	48	Φ3/4	Φ1-1/8	Φ1-3/8	18+18+25	25+25+30	694×2+816
GMV-Q336WM/B-U(U)		312,000	320,000	(52-3/4×30-1/8×63-1/4)×3	8240×3	0.33	67	48	Φ3/4	Φ1-1/8	Φ1-3/8	18+25+25	25+30+30	694+816×2
GMV-Q360WM/B-U(U)		334,000	360,000	(52-3/4×30-1/8×63-1/4)×3	8240×3	0.33	67	48	Φ3/4	Φ1-3/8	Φ1-5/8	25+25+25	30+30+30	816×3

\*Note: Rated capacity is certified under AHRI Standard 1230. Ratings are subject to change without notice. Current certified ratings are available at [www.ahridirectory.org](http://www.ahridirectory.org).

# GMV MTAC

GMV MTAC is a kind of concealed VRF unit, which cancel front side air discharge and air return. It's mainly developed for the North American market, which is applicable for apartments, offices, hotels and other areas. The unit adopts deep subcooling technology for ensuring the quiet cooling operation. Moreover, the unique drainage control technology has solved the problem of water drainage of the outdoor unit under a low-temperature environment.



High efficiency

Low temperature heating

Golden fin condenser

Quality motor

Easier maintainability

Low voltage startup

- The system adopts all DC motor, which greatly improves efficiency. The energy efficiency for all Gree DC units is increased greatly. SEER=15.5, HSPF=9.5.
- The latest communication way-CAN bus communication is adopted, which greatly improves anti-interference ability, precisely controls the indoor units and improves the reliability of the system. Meanwhile, a specialized shielded wire is no longer needed, while conventional communication wire can be used to increase the flexibility of project installation.
- The system can operate constantly and reliably in a wide temperature range(cooling: 23~118.4°F/-5~48°C, heating: -4~80.6°F/-20~27°C), which is not affected by an atrocious environment.
- A series of optimized measures are taken to solve the problem of indoor unit's throttling sound, indoor unit's oil return noise, gas bypass noise during start-up, which improves the comfort of the system.
- The system applies the original technology of PID intelligent capacity adjustment, which quickly and precisely controls indoor ambient temperature according to set temperature, with small temperature fluctuation and great comfort.



Max. piping length (m(ft.))	GMV MTAC
Total piping length	30(98-3/8)
Actual piping length	30(98-3/8)
Height difference between indoor units	15(49-2/8)
Height difference between ODU and IDU(ODU is located above the IDU)	15(49-2/8)
Height difference between ODU and IDU(IDU is located above the ODU)	15(49-2/8)
Piping length from first indoor branch to the farthest IDU	10(32-6/8)

Item	Nominal operating condition (temperature)				Operating range (temperature)
	Outdoor condition		Indoor condition		Outdoor condition DB(°F/°C)
	DB(°F/°C)	WB(°F/°C)	DB(°F/°C)	WB(°F/°C)	GMV MTAC
Cooling	95/35	75/23.9	80/26.7	67/19.4	23~118.4/-5~47.8
Heating	47/8.3	43/6.1	70/21.1	60/15.6	-4~80.6/-20~27.2

Model	-	GMV-12WP/A-T(U)*
Capacity range	Ton	1
Capacity	Cooling	Btu/h 12000
	Heating	Btu/h 12000
Air flow volume	CFM	500
Power supply	V/Ph/Hz	208/230/1/60
Maximum drive IDU NO.	unit	2
Refrigerant charge volume	lbs	1.8
Sound pressure level	dB(A)	Indoor46/Outdoor57
Connecting pipe	Liquid	In. 1/4
	Gas	In. 1/2
Dimension (W×D×H)	Outline	In. 42-1/16×19-11/16×16
	Package	In. 45-15/16×23-12/16×19-2/16
Net weight/Gross weight	lbs	121/139
Build in water pump	Total head lift	In. 137-6/8
Loading quantity	40' GP	set 120
	40' HQ	set 150

\*Note: This product is under development. Please confirm the final specifications with sales representatives.



# WATER-COOLED GMV





# GMV Water

Water Source Heat Pump VRF System integrates the advantages of a water system and DC inverter VRF units. It features the high efficiency and energy saving of water-cooled units and the comfortable and flexible characteristics of VRF units. It utilizes renewable sources as the heating and cooling sources. It can be used in coordination with relevant policy projects or energy conservation projects, providing a new air conditioning solution for tall building structures, hotels, office buildings, shopping centers, etc.



6/8/10 Ton



High efficiency



Energy saving function



Quiet function



Wide voltage range



Wide operation range



Modular operating



Comprehensive protection

- An external energy source for water source heat pump VRF system  
Gree self-developed water source heat pump VRF system utilizes renewable sources such as water and geo-thermal or ground, with higher operating efficiency and lower energy consumption. The waterside can be a cooling tower or boiler or the application of surface water (river water, lake water, seawater), groundwater, geo-thermal or ground heat, solar power, waste heat, wastewater or other kinds of renewable sources.
- System structure of water source heat pump VRF system  
The water source heat pump VRF system is made up of two parts. The first part is the water system that exchanges heat between outdoor units and water/geo-thermal or ground sources. The application of water source/geo-thermal or ground source is varied and can be coordinated with constant-temperature water/geo-thermal or ground, cooling tower or boiler. Compared with the common air-cooled system, it is more energy-saving and space-saving. The second part is the VRF system of outdoor and indoor units, which features the advantages of flexible installation, easy construction, and intelligent control. There is a variety of combinations of indoor units to cope with different applications.
- Suitable for different construction applications, no influence on building appearance  
The water source heat pump VRF system is suitable for different constructions, with no influence on building appearance. The water source heat pump VRF air conditioners do not need to exchange heat with the outdoor air, so it can be installed flexibly to coordinate with the building structure.
- No influence of weather  
The water source heat pump VRF system exchanges heat with water or geo-thermal or ground source through outdoor units, so it won't be affected by the air temperature. In winter, when the system is in the heating operation, outdoor units won't get frosted or run in defrosting mode, so as to guarantee stable heating performance.
- Same as GMV5, the water source heat pump VRF system adopts CAN communication, so it can be connected with any one type of GMV5 indoor units.



Max. piping length (m(ft.))	GMV Water
Total piping length	300(984-1/4)
Actual piping length	165(541-5/16)
Equivalent piping length	190(623-3/8)
Height difference between indoor units	30(98-7/16)
Height difference between ODU and IDU(ODU is located above the IDU)	50(164-1/16)
Height difference between ODU and IDU(ODU is located below the IDU)	50(164-1/16)
Piping length from first indoor branch to the farthest IDU	40(131-1/4)

Item	Nominal operating condition (temperature)		Operating range (temperature) Water Temp. DB(°F/ )
	Indoor condition		
	DB(°F/ )	WB(°F/ )	GMV Water
Cooling	80/26.7	67/19.4	50~122/10~50
Heating	70/21.1	60/15.6	50~122/10~50

## GMV Water Heat Recovery<sup>4</sup>/ Water Heat Pump<sup>5</sup>

Specifications		Model name		
Unit type		GMV-WQ72WM/A-F(U)	GMV-WQ96WM/A-F(U)	GMV-WQ120WM/A-F(U)
<b>Performance</b>				
Rated cooling capacity <sup>1</sup>	Btu/h	69,000	92,000	114,000
Rated heating capacity <sup>1</sup>	Btu/h	77,000	103,000	129,000
Operating water temperature range	Cooling(°F)	50~122		
	Heating(°F)	50~122		
AHRI ratings(ducted/non-ducted) <sup>2</sup>	EER	15.0/17.0	14.0/14.5	13.0/13.0
	IEER	26.0/28.0	25.0/26.0	24.0/26.0
	COP	5.2/6.0	5.0/5.0	4.2/5.0
	SCHE	24/27	23/26	22/25
Suond pessure levels	dB(A)	48	50	51
<b>Dimension</b>				
External dimensions (H×W×D)	In.(mm)	(30 11/16×21 5/8×39 3/8)(780×550×1000)		
Net weight	lbs	370	375	377
Refrigerant piping diameter (In.)	Liquid	3/8	3/8	1/2
	Gas (Low Pressure)	3/4	7/8	1-1/8
	Gas (High Pressure)	5/8	3/4	7/8
Max. length hrom ODU to last header	Ft	541-5/16		
Max. total refrigerant line length	Ft.	984-1/4		
Max. height difference between ODU&IDU	Ft.	164-1/16	295-1/4	
Max. control wiring length	Ft.	3280-5/6		
<b>Electrical data</b>				
Power supply requirement	/	208~230V/3Ph/60Hz		
Minimum circuit ampacity (MCA)	A	23	28	38
Maximum overcurrent protection (MOP)	A	25	35	45
<b>Circulating water</b>				
Pressure drop	psi	3.2	5.8	8.6
Operation water volume range	GPM	21~49		
Maximum water pressure	psi	285		
Water side connection inlet and outlet	In	1-1/4		
<b>Other</b>				
Indoor unit	Total Capacity	50%~135%		
	Max Connect-able Quantity	13	16	19
Compressor operating range	%~%	20%~100%		
Compressor type×quantity		Scroll×1		
Refrigerant		R410A		

Note:  
 1.Nominal capacity based on 25ft. of equivalent refrigerant piping with 0ft. level difference.  
 Cooling: Indoor temperature 80°F/27°C DB, 67°F/19°C WB; Entering water temperature 86°F/30°C.  
 Heating: Indoor temperature 70°F/26°C DB, 60°F/16°C; Enter water temperature 68°F/20°C.

2.Rated per AHRI 1230 Standard conditions.

3.GMV water heat pump should be placed at the ambient temperature of 50°F~122°F (10~50°C).

4. All models of this series are under development. Please confirm the final specifications with the sales representatives.

5. The Water Heat Recovery series and the Water Heat Pump series are the same models.

## ODU Combination Lineup\*

Model	GMV-WQ72WM/A-F(U) (6 Ton)	GMV-WQ96WM/A-F(U) (8 Ton)	GMV-WQ120WM/A-F(U) (10 Ton)
GMV-WQ72WM/A-F(U) (6 Ton)	●		
GMV-WQ96WM/A-F(U) (8 Ton)		●	
GMV-WQ120WM/A-F(U) (10 Ton)			●
GMV-WQ144WM/A-F(U) (12 Ton)	● ●		
GMV-WQ168WM/A-F(U) (14 Ton)	●	●	
GMV-WQ192WM/A-F(U) (16 Ton)		● ●	
GMV-WQ216WM/A-F(U) (18 Ton)		●	●
GMV-WQ240WM/A-F(U) (20 Ton)			● ●
GMV-WQ264WM/A-F(U) (22 Ton)	●	● ●	
GMV-WQ288WM/A-F(U) (24 Ton)		● ● ●	
GMV-WQ312WM/A-F(U) (26 Ton)		● ●	●
GMV-WQ336WM/A-F(U) (28 Ton)		●	● ●
GMV-WQ360WM/A-F(U) (30 Ton)			● ● ●

## Specifications of ODU Combination\*

Model	Power supply V/Ph/Hz	Cooling		Dimension(W×D×H) In.	Connecting		MCA A	MOP A	Weight lbs
		Cooling Btu/h	Heating Btu/h		Liquid pipe In.	Gas pipe In.			
GMV-WQ144WM/A-F(U)	208/230/3/60	144,000	162,000	2sets:30 5/7×21 2/3×39 3/8	3/8"+3/8"	3/4"+3/4"	23+23	25+25	370+370
GMV-WQ168WM/A-F(U)		168,000	189,000	2sets:30 5/7×21 2/3×39 3/8	3/8"+3/8"	3/4"+7/8"	23+28	25+35	370+375
GMV-WQ192WM/A-F(U)		192,000	216,000	2sets:30 5/7×21 2/3×39 3/8	3/8"+3/8"	7/8"+7/8"	28+28	35+35	375+375
GMV-WQ216WM/A-F(U)		216,000	243,000	2sets:30 5/7×21 2/3×39 3/8	3/8"+1/2"	7/8"+1 1/8"	28+38	35+45	375+377
GMV-WQ240WM/A-F(U)		240,000	270,000	2sets:30 5/7×21 2/3×39 3/8	1/2"+1/2"	1 1/8"+1 1/8"	38+38	45+45	377+377
GMV-WQ264WM/A-F(U)		264,000	297,000	3sets:30 5/7×21 2/3×39 3/8	3/8"+3/8"+3/8"	3/4"+7/8"+7/8"	23+28+28	25+35+35	370+375+375
GMV-WQ288WM/A-F(U)		288,000	324,000	3sets:30 5/7×21 2/3×39 3/8	3/8"+3/8"+3/8"	7/8"+7/8"+7/8"	28+28+28	35+35+35	375+375+375
GMV-WQ312WM/A-F(U)		312,000	351,000	3sets:30 5/7×21 2/3×39 3/8	3/8"+3/8"+1/2"	7/8"+7/8"+1 1/8"	28+28+38	35+35+45	375+375+377
GMV-WQ336WM/A-F(U)		336,000	378,000	3sets:30 5/7×21 2/3×39 3/8	3/8"+1/2"+1/2"	7/8"+1 1/8"+1 1/8"	28+38+38	35+45+45	375+377+377
GMV-WQ360WM/A-F(U)		360,000	405,000	3sets:30 5/7×21 2/3×39 3/8	1/2"+1/2"+1/2"	1 1/8"+1 1/8"+1 1/8"	38+38+38	45+45+45	377+377+377

\*Note: The combination AHRI listing is not available.



# GMV5 Solar





# GMV5 Solar Generation II

Gree GMV5 Solar Generation II adopts inverter compressor technology, with capacities ranging from 3 tons to 10 tons. It has a broad product lineup and is widely applicable to places such as residential houses, apartments, and office buildings.



- With LAN reverse power control technology; efficiency of PV power generation/consumption is more than 99%
- Active grid configuration, automatically identifying 208/240V and 60Hz and other global power supply type
- Adopt a high-efficiency DC inverter compressor for realizing broadband operation, high efficiency, and low noise
- Adopt all-new aluminum-plastic design, with stronger heat dissipation capability and longer service life (components)
- Adopt modular design concept for the unit's structure to realize fast-assembly as well as fast-disassembly for all parts
- The build-in smart energy control module can freely connect to Gree self-developed information Energy Management System (IEMS) for smart energy distribution
- This function is upgradeable. An energy storage unit is optional. The upgrade from PV air conditioning to PV storage air conditioning should match with our energy management system solution.



## Specifications

Model	-	GMV-Y36WL/A-T(U)*	GMV-Y48WL/A-T(U)*	GMV-Y60WL/A-T(U)*
Capacity range	Ton	3	4	5
Capacity	Cooling	Btu/h	37,500	48,000
	Heating	Btu/h	42,000	54,000
Air flow volume	CFM	3531	3708	3884
Power supply	V/Ph/Hz	208/240~1~60	208/240~1~60	208/240~1~60
Minimum Circuit Ampacity (MCA)	A	AC 30A DC 12A	AC 30A DC 12A	AC 30A DC 12A
Maximum Overcurrent Protection (MOP)	A	AC/DC 38A/15A	AC/DC 38A/15A	AC/DC 38A/15A
Range of allowable open circuit input voltage	V	120-440	120-440	120-440
Range of Input operating voltage	V	AC 208/240V DC 100-380V	AC 208/240V DC 100-380V	AC 208/240V DC 100-380V
Max. solar short circuit current	A	15	15	15
Recommended quantity of solar panel *Base on Yingli model YL325D-36b	/	8/16	8/16	8/16
Maximum drive IDU NO.	/	7	8	9
Refrigerant charge volume	lbs/Oz	7.275/116.4	7.275/116.4	7.275/116.4
Sound pressure level	dB(A)	57	58	59
Connecting pipe	Liquid	In.	3/8	3/8
	Gas	In.	5/8	5/8
Dimension (W×D×H)	Outline	In.	35-7/16×13-3/8×53	35-7/16×13-3/8×53
	Package	In.	39-5/16×18×59	39-5/16×18×59
Net weight/Gross weight	lbs	271.2/293.3	271.2/293.3	271.2/293.3
Loading quantity	40' GP	set	57	57
	40' HQ	set	57	57

Model	-	GMV-Y72WM/C-F(U)	GMV-Y96WM/C-F(U)	GMV-Y120WM/C-F(U)
Capacity range	Ton	6	8	10
Rated capacity**	Cooling	Btu/h	69,000	92,000
	Heating	Btu/h	77,000	103,000
Air flow volume	CFM	6710	8240	8240
Power supply	V/Ph/Hz	208/240~3~60	208/240~3~60	208/240~3~60
Minimum Circuit Ampacity (MCA)	A	35.3(208V)/30.3(240V)	43.6(208V)/37.3(240V)	44.8(208V)/39.8(240V)
Maximum Overcurrent Protection (MOP)	A	45.0(208V)/40.0(240V)	45.0(208V)/40.0(240V)	45.0(208V)/40.0(240V)
Max. PV Input voltage	V	1000	1000	1000
Range of input operating voltage	V	400~780	400~780	400~780
Max. solar short circuit current	A	39	39	39
Recommended quantity of solar panel *Base on Yingli model YL325D-36b	/	18/36	18/36	18/36
Maximum drive IDU NO.	/	13	16	19
Refrigerant charge volume	lbs	14.33	24.91	26.01
Sound pressure level	dB(A)	60	61	63
Connecting pipe	Liquid	In.	Φ3/8	Φ3/8
	Gas	In.	Φ3/4	Φ7/8
	Oil balance	In.	Φ3/8	Φ3/8
Dimension (W×D×H)	Outline	In.	36-5/8×30-1/8×63-1/4	52-3/4×30-1/8×63-1/4
	Package	In.	39-3/4×33-1/8×69-7/8	55-7/8×33-1/8×69-7/8
Net weight/Gross weight*	lbs	487/514	650/683	650/683
Loading quantity	40' GP	set	24	16
	40' HQ	set	24	16

\*Note: The weight as above does not include the converter's weight.

\*\*Note: Rated capacity is certified under AHRI Standard 1230. Ratings are subject to change without notice. Current certified ratings are available at [www.ahridirectory.org](http://www.ahridirectory.org).

Model	GIE-ADC12K5E
<b>INVERTER SPECIFICATIONS</b>	
Rated AC voltage	208 / 240V AC 3~ + PE
Rated AC power	12.5kW
Rated AC current	35A *3 / 30A *3
Output frequency and accuracy	60Hz±1Hz
Max. PV input voltage(OC)	1000V DC
MPPT range	400V—780V
Isc PV	39A
Max. continuous input current	2*14A
Max. PV input power	14kW
Max. DC continuous output current	25A
Rated DC output current	25A
DC output voltage	400V—780V
Power factor	-0.8~0.8
Ambient temperature	-20°C~50°C ( -4°F~122°F )
Total Harmonic Distortion (THD)	<3%
Inverter efficiency (Peak)	97.60%
Overtemperature protection	Yes
Overtemperature protection	Yes
Ingress protection	TYPE 3
Operating humidity	0~95%
Certification	UL 1741 IEEE 1547
<b>PHYSICAL SPECIFICATIONS</b>	
Dimensions (L×W×H)	12-1/8×8-1/8×43-5/8 (In.) 307×204.5×1109 (mm)
Mounting	Vertical
Net weight	45 (kg) / 99 (Lbs.)
Gross weight	47 (kg) /104 (Lbs.)

**ODU Combination Lineup**

Model	GMV-Y72WM/C-F(U) (6Ton)	GMV-Y96WM/C-F(U) (8Ton)	GMV-Y120WM/C-F(U) (10Ton)
GMV-Y72WM/C-F(U) (6Ton)	●		
GMV-Y96WM/C-F(U) (8Ton)		●	
GMV-Y120WM/C-F(U) (10Ton)			●
GMV-Y144WM/C-F(U) (12Ton)**	● ●		
GMV-Y168WM/C-F(U) (14Ton)**	●	●	
GMV-Y192WM/C-F(U) (16Ton)**		● ●	
GMV-Y216WM/C-F(U) (18Ton)**		●	●
GMV-Y240WM/C-F(U) (20Ton)**			● ●
GMV-Y264WM/C-F(U) (22Ton)**	●	● ●	
GMV-Y288WM/C-F(U) (24Ton)**		● ● ●	
GMV-Y312WM/C-F(U) (26Ton)**		● ●	●
GMV-Y336WM/C-F(U) (28Ton)**		●	● ●
GMV-Y360WM/C-F(U) (30Ton)**			● ● ●

\*Note: This series is under development. Gree reserves the right to modify the specifications without prior notice.

\*\*Note: There is no AHRI Certificate for modular unit.

**Specification of ODU Combination**

**208V**

Model	Power supply V/ Ph /Hz	Capacity		Dimension(W×D×H) In.	Airflow volume CFM	ESP In.W.G	Sound pres- sure dB(A)	Oper- ation sound dB(A)	Connecting pipe diameter		Oil balance In.	MCA A	MOP A	Weight lbs
		Cooling Btu/h	Heating Btu/h						Liquid In.	Gas In.				
GMV-Y144WM/ C-F(U)**	208-3-60	144,000	162,000	(36-5/8×30-1/8×63-1/4)×2	6710×2	0.33	64	48	Φ1/2	Φ1-1/8	Φ3/8	35.3+35.3	45+45	487×2
GMV-Y168WM/ C-F(U)**		168,000	189,000	(36-5/8×30-1/8×63-1/4)+ (52-3/4×30-1/8×63-1/4)	6710+8240	0.33	64	48	Φ5/8	Φ1-1/8	Φ3/8	35.3+43.6	45+45	487+650
GMV-Y192WM/ C-F(U)**		192,000	216,000	(52-3/4×30-1/8×63-1/4)×2	8240×2	0.33	64	48	Φ5/8	Φ1-1/8	Φ3/8	43.6+43.6	45+45	650×2
GMV-Y216WM/ C-F(U)**		216,000	243,000	(52-3/4×30-1/8×63-1/4)×2	8240×2	0.33	65	48	Φ5/8	Φ1-1/8	Φ3/8	43.6+44.8	45+45	650×2
GMV-Y240WM/ C-F(U)**		240,000	270,000	(52-3/4×30-1/8×63-1/4)×2	8240×2	0.33	65	48	Φ5/8	Φ1-3/8	Φ3/8	44.8+44.8	45+45	650×2
GMV-Y264WM/ C-F(U)**		264,000	297,000	(36-5/8×30-1/8×63-1/4)+ (52-3/4×30-1/8×63-1/4)×2	6710+8240×2	0.33	66	48	Φ3/4	Φ1-3/8	Φ3/8	35.3+43.6+43.6	45+45+45	487+650×2
GMV-Y288WM/ C-F(U)**		288,000	324,000	(52-3/4×30-1/8×63-1/4)×3	8240×3	0.33	66	48	Φ3/4	Φ1-3/8	Φ3/8	43.6+43.6+43.6	45+45+45	650×3
GMV-Y312WM/ C-F(U)**		312,000	351,000	(52-3/4×30-1/8×63-1/4)×3	8240×3	0.33	66	48	Φ3/4	Φ1-3/8	Φ3/8	43.6+43.6+44.8	45+45+45	650×3
GMV-Y336WM/ C-F(U)**		336,000	378,000	(52-3/4×30-1/8×63-1/4)×3	8240×3	0.33	67	48	Φ3/4	Φ1-3/8	Φ3/8	43.6+44.8+44.8	45+45+45	650×3
GMV-Y360WM/ C-F(U)**		360,000	405,000	(52-3/4×30-1/8×63-1/4)×3	8240×3	0.33	67	48	Φ3/4	Φ1-5/8	Φ3/8	44.8+44.8+44.8	45+45+45	650×3

**240V**

Model	Power supply V/ Ph /Hz	Capacity		Dimension(W×D×H) In.	Airflow volume CFM	ESP In.W.G	Sound pres- sure dB(A)	Oper- ation sound dB(A)	Connecting pipe diameter		Oil balance Pipe In.	MCA A	MOP A	Weight lbs
		Cooling Btu/h	Heating Btu/h						Liquid In.	Gas In.				
GMV-Y144WM/ C-F(U)**	240-3-60	144,000	162,000	(36-5/8×30-1/8×63-1/4)×2	6710×2	0.33	64	48	Φ1/2	Φ1-1/8	Φ3/8	30.3+30.3	40+40	487×2
GMV-Y168WM/ C-F(U)**		168,000	189,000	(36-5/8×30-1/8×63-1/4)+ (52-3/4×30-1/8×63-1/4)	6710+8240	0.33	64	48	Φ5/8	Φ1-1/8	Φ3/8	30.3+37.3	40+40	487+650
GMV-Y192WM/ C-F(U)**		192,000	216,000	(52-3/4×30-1/8×63-1/4)×2	8240×2	0.33	64	48	Φ5/8	Φ1-1/8	Φ3/8	37.3+37.3	40+40	650×2
GMV-Y216WM/ C-F(U)**		216,000	243,000	(52-3/4×30-1/8×63-1/4)×2	8240×2	0.33	65	48	Φ5/8	Φ1-1/8	Φ3/8	37.3+39.8	40+40	650×2
GMV-Y240WM/ C-F(U)**		240,000	270,000	(52-3/4×30-1/8×63-1/4)×2	8240×2	0.33	65	48	Φ5/8	Φ1-3/8	Φ3/8	39.8+39.8	40+40	650×2
GMV-Y264WM/ C-F(U)**		264,000	297,000	(36-5/8×30-1/8×63-1/4)+ (52-3/4×30-1/8×63-1/4)×2	6710+8240×2	0.33	66	48	Φ3/4	Φ1-3/8	Φ3/8	30.3+37.3+37.3	40+40+40	487+650×2
GMV-Y288WM/ C-F(U)**		288,000	324,000	(52-3/4×30-1/8×63-1/4)×3	8240×3	0.33	66	48	Φ3/4	Φ1-3/8	Φ3/8	37.3+37.3+37.3	40+40+40	650×3
GMV-Y312WM/ C-F(U)**		312,000	351,000	(52-3/4×30-1/8×63-1/4)×3	8240×3	0.33	66	48	Φ3/4	Φ1-3/8	Φ3/8	37.3+37.3+39.8	40+40+40	650×3
GMV-Y336WM/ C-F(U)**		336,000	378,000	(52-3/4×30-1/8×63-1/4)×3	8240×3	0.33	67	48	Φ3/4	Φ1-3/8	Φ3/8	37.3+39.8+39.8	40+40+40	650×3
GMV-Y360WM/ C-F(U)**		360,000	405,000	(52-3/4×30-1/8×63-1/4)×3	8240×3	0.33	67	48	Φ3/4	Φ1-5/8	Φ3/8	39.8+39.8+39.8	40+40+40	650×3

Note: This series are under development. Please confirm the final specifications with the sales representatives.

\*\*Note: There is no AHRI Certificate for modular unit.



# Ultra Heat GMV





# Ultra Heat GMV

Gree Ultra Heat GMV adopts a multi-cylinder jet type compressor to ensure strong heating capacity. Its EER reaches 13, with a capacity range from 36K to 96K. It has a broad product lineup and is widely applicable to places such as residential houses, apartments, and office buildings.



36/48K



72/96K



XK46



YAP1F



High efficiency



Golden fin condenser



Turbo function



Low temperature heating



Centralized control



Long-distance monitoring

- SEER is 20.5 and HSPF up to 11.7, certified with NA Energy Star
- Stable operation under -31°F/-35°C
- The capacity ratio of indoor and outdoor units is 50%~100%
- 17 indoor units connectable in maximum
- Highly efficient DC inverter control technology adopted
- With CAN communication technology, connectable to GMV5 indoor units
- Heating performance is not weakened even at -4°F/-20°C



## Specifications

Model		-	GMV-36WL/B-T(U)	GMV-48WL/B-T(U)	GMV-V72W/A-F(U)	GMV-V96W/A-F(U)
Capacity range		Ton	3	4	6	8
Capacity	Cooling	kBtu	36	48	69	92
	Heating	kBtu	45	54	77	103
Power supply		V/Ph/Hz	208/230/1/60	208/230/1/60	208/230/3/60	208/230/3/60
MCA		A	37	37	40	45
MOP		A	50	50	50	60
Airflow Volume		CFM	3531	3531	8239	8239
Sound pressure level		dB	56	57	60	60
Maximum drive IDU NO.		/	5	6	12	17
Refrigerant charge volume		lbs/Oz	14.33/229.3	14.33/229.3	24.25/388	24.25/388
Operating range		°F	-31~129	-31~129	-22~125.6	-22~125.6
Cooling (Non-ducted /Ducted)	Rated capacity	Btu/h	36000/36000	48000/48000	69000/69000	92000/92000
	Capacity range	Btu/h	7500~36000	7500~48000	7500~69000	7500~92000
	Rated total Input	W	2500/3085	3850/4750	6000/6160	8000/8360
Heating at 47°F (Non-ducted /Ducted)	Rated capacity	Btu/h	45000/45000	54000/54000	77000/77000	103000/103000
	Capacity range	Btu/h	8500~45000	8500~54000	8500~77000	8500~103000
	Rated total Input	W	3125/3820	4050/4560	6100/6270	8390/8630
Heating at 17°F (Non-ducted /Ducted)	Rated capacity	Btu/h	41000/41000	52500/53000	64000/60000	76000/72000
	Capacity range	Btu/h	8500~45000	8500~54000	8500~64000/8500~60000	8500~76000/8500~72000
	Rated total Input	W	4657/5410	5872/6812	7891/7815	9478/9379
Heating at 5°F	Maximum capacity	Btu/h	45000	54000	77000	103000
Efficiency	SEER(Non-ducted /Ducted)		20.5/16.5	20/16.5	/	/
	EER(Non-ducted /Ducted)		13/11.3	12.5/9.5	11.5/11.2	11.5/11
	COP(Non-ducted /Ducted)		4/3.52	3.9/3.36	3.7/3.6	3.6/3.5
	HSPF(Non-ducted /Ducted)		11.7/10.3	11/10.2	/	/
Connecting pipe	Liquid	In.	3/8	3/8	1/2	1/2
	Gas(Low pressure)	In.	5/8	5/8	1 1/8	1 1/8
	Gas(High pressure)	In.	/	/	/	/
Dimension (W×D×H)	Outline	In.	35-3/7×13-2/5×53	35-3/7×13-2/5×53	52-3/4×30-1/8×63-1/8	52-3/4×30-1/8×63-1/8
	Package	In.	39-2/7×18×59-2/3	39-2/7×18×59-2/3	56×33×69-7/8	56×33×69-7/8
Loading quantity	40'GP	set	57	57	16	16
	40'HQ	set	57	57	16	16

Model		-	GMV-VQ72W/A-F(U)	GMV-VQ96W/A-F(U)	GMV-V96W/A-F(U)+G-MV-V96W/A-F(U)	GMV-VQ96W/A-F(U)+G-MV-VQ96W/A-F(U)
Capacity range		Ton	6	8	16	16
Capacity	Cooling	kBtu	69	92	184	184
	Heating	kBtu	77	103	200	200
Power supply		V/Ph/Hz	208/230/3/60	208/230/3/60	208~230/3/60	208~230/3/60
MCA		A	40	45	45+45	45+45
MOP		A	50	60	60+60	60+60
Airflow Volume		CFM	8239	8239	16460	16460
Sound pressure level		dB	60	60	60	60
Maximum drive IDU NO.		/	12	17	34	34
Refrigerant charge volume		lbs/Oz	27.56/441	27.56/441	48.5/776	55.12/882
Operating range		°F	-22~125.6	-22~125.6	-22~125.6	-22~125.6
Cooling (Non-ducted /Ducted)	Rated capacity	Btu/h	69000/69000	92000/92000	184000/184000	184000/184000
	Capacity range	Btu/h	7500~69000	7500~92000	7500~184000/7500~184000	7500~184000/7500~184000
	Rated total Input	W	6000/6160	8360/8360	17360/17360	17360/17360
Heating at 47°F (Non-ducted /Ducted)	Rated capacity	Btu/h	77000	103000	200000/200000	200000/200000
	Capacity range	Btu/h	8500~77000	8500~103000	8500~200000/8500~200000	8500~200000/8500~200000
	Rated total Input	W	6270/6700	8630/9010	17240/18320	17240/18320
Heating at 17°F (Non-ducted /Ducted)	Rated capacity	Btu/h	64000/60000	76000/72000	152000/142000	152000/142000
	Capacity range	Btu/h	8500~64000/8500~60000	8500~76000/8500~72000	8500~152000/8500~142000	8500~152000/8500~142000
	Rated total Input	W	7981/7815	9478/9379	19369/20301	19369/20301
Heating at 5°F	Maximum capacity	Btu/h	77000	103000	200000	200000
Efficiency	SEER(Non-ducted /Ducted)		/	/	/	/
	EER(Non-ducted /Ducted)		11.5/11.2	11/11	10.6/10.6	10.6/10.6
	COP(Non-ducted /Ducted)		3.6/3.37	3.5/3.35	3.4/3.2	3.4/3.2
	HSPF(Non-ducted /Ducted)		/	/	/	/
Connecting pipe	Liquid	In.	1/2	1/2	5/8	5/8
	Gas(Low pressure)	In.	1 1/8	1 1/8	1 1/4	1 1/4
	Gas(High pressure)	In.	3/4	3/4	/	1 1/8
Dimension (W×D×H)	Outline	In.	52 3/4×30 1/8×63 1/8	52 3/4×30 1/8×63 1/8	52 3/4×30 1/8×63 1/8	52 3/4×30 1/8×63 1/8
	Package	In.	56×33×69 7/8	56×33×69 7/8	56×33×69 7/8	56×33×69 7/8
Loading quantity	40'GP	set	16	16	16	16
	40'HQ	set	16	16	16	16

# Indoor Units



# Indoor Units Lineup

Type of indoor unit	Product	5	6	7	9	12	14	15	18	22	24	30	36	42	48	54	72	96	192
High Static Pressure Duct Unit									●		●	●	●	●	●		●	●	
Super High Static Pressure Duct Unit				●	●	●		●	●	●	●	●	●	●	●	●	●	●	
Medium Static Pressure Duct Unit												●	●	●	●				
Low Static Pressure Duct Unit				●	●	●	●		●	●	●								
4-way Cassette Unit				●	●	●		●	●		●	●	●	●	●				
360° Air Discharge Cassette Indoor Unit				●	●	●		●	●	●	●	●	●	●	●				
360° Air Discharge Compact Cassette Unit		●		●	●	●		●	●										
2-Way Cassette Unit					●	●		●	●		●								
1-Way Cassette Unit				●	●	●													
Wall-mounted Type			●	●	●	●	●		●		●	●	●						
Console			●	●	●	●			●			●							
Floor Ceiling Type					●	●			●		●	●	●	●	●	●			
Air Handler					●	●			●		●	●	●	●	●	●			
Fresh Air Processing Unit														●	●	●	●	●	
AHU-KIT						●					●				●			●	●

## High Static Pressure Duct Unit \*



- High static pressure design**  
 Static pressure can be up to 200Pa(0.8In.W.G), especially suitable for places in need of long distance airflow.
- Convenient installation**  
 You can choose a circular air duct or rectangular air duct according to actual needs. Or you can choose different ways of air return.
- Easy maintenance**  
 The system has a maintenance port for easy maintenance.
- Protection function**  
 Anti-freezing protection, fan motor overload protection, and temperature sensor malfunction protection.

\*Note: This series will be phased out during 2020.



## Super High Static Pressure Duct Unit



- **High static pressure design**

Static pressure can be up to 275Pa(1.1 In.W.G), especially suitable for places in need of long distance airflow.

- **Easy maintenance**

The system has maintenance window for easy maintenance.

- **Convenient installation**

You can choose circular air duct or rectangular air duct according to actual needs. Or you can choose different ways of air return.

- **Protection function**

Anti-freezing protection, fan motor overload protection, temperature sensor malfunction protection.

## Medium Static Pressure Duct Unit



- **Medium static pressure design with multiple static pressure levels for your option**

External static pressure design reaches 80Pa (0.3In.W.G) for multiple air supply areas and long air supply distance, satisfying various layout requirements. With five external static pressure levels, convenient for engineering design and application.

- **DC motor design with energy-saving and quiet operation**

DC brushless motor is adopted to achieve step-less adjustment of rotation speed, more stable speed adjustment and quieter operation.

- **Intelligent drain device without height limitation**

DC drain pump is equipped with a maximum lift height of 1m, solving the condensate drainage problem caused by small installation space and saving the installation space.

- **Multiple protections function**

Water-full protection, freeze prevention, abnormal temperature sensor protection and built-in fan overload protection, etc.

## Low Static Pressure Duct Unit



- **Low static pressure, low noise**

Especially suitable for rooms of compact structure or small installation space. Moreover, it provides you with a comfortable and quiet living environment.

- **Intelligent drainage device**

Water height difference up to 1.2m(3-15/16ft.), which can effectively drain out condensing water and save space.

Note: Please specify if you need this function.

- **Convenient installation**

Tab type plastic filter, detachable fan motor, independent water pump assembly and electric box assembly, all for convenient maintenance.

- **Protection function**

Water overflow protection, anti-freezing protection, fan motor overload protection, and temperature sensor malfunction protection.

## 4-way Cassette Unit\*

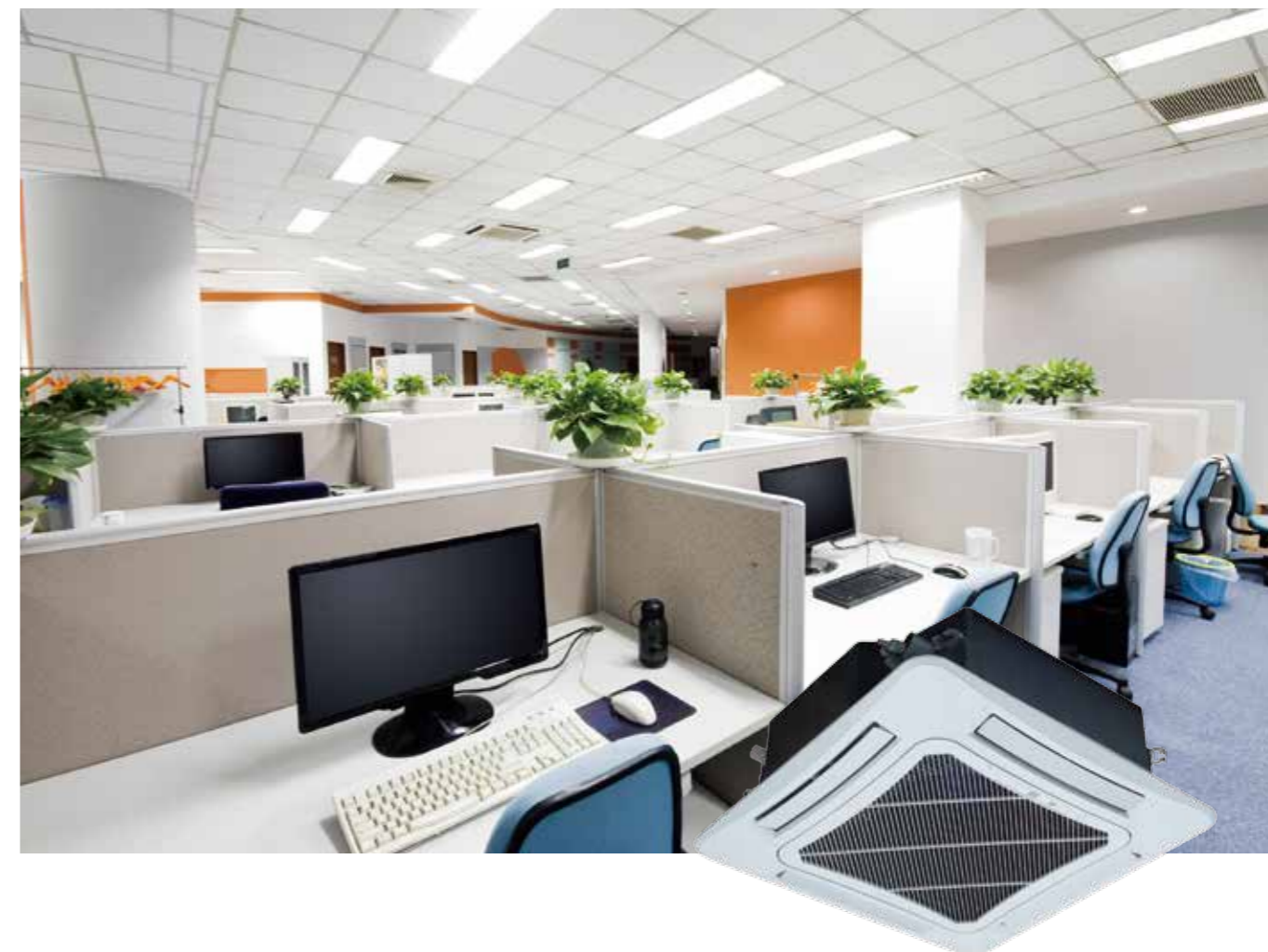

- **Strong and balanced airflow**

The unit features auto operation, 4-way airflow, 7 fan speeds and strong circulating airflow.

- **Ultra-low noise operation**

Utilizes variable speed DC inverter motor technology for very quiet operation. The indoor unit incorporates a quiet mode function via the wired controller.

- **Intelligent drainage device**

Water height difference up to 1.2m(3-15/16ft.), which can effectively drain out condensing water and save space.

\*Note: This series will be phased out during 2020.

- **DC inverter motor**

With good speed regulation performance, motor efficiency improved by 30% v.s. normal motor.

- **Protection function**

Condensate pan overflow protection, anti-freezing protection, temperature sensor malfunction protection, and fan motor overload protection.



## 360° Air Discharge Cassette Indoor Unit



- **360° Air supply**

360 ° air supply design to make indoor airflow more even and temperature distribution more comfortable to avoid any blind angle.

- **Individual swing control**

Individual swing control of four air guide louvers to set fixed supply air or swing supply air in different angles individually, satisfying the user's individualized requirements on temperature and air flow distribution in different indoor locations, thus enhancing comfort.

- **Lifting water pump of condensate**

With direct current drainage pump, the operation noise is lower and the lift reaches 1,200mm.

- **Fresh air function**

With the healthy fresh air accessories, it can bring in 8%~10% of fresh outdoor air effectively, improving the air quality of the indoor unit.

- **I-feel technology\***

Advanced I-feel technology can detect human indoor activities in real time and realize intelligent control to the operation status of the indoor unit, thus reaching a higher energy conservation level.

Note: \* This function is custom-made.

## Fresh Air Ventilation Kit



- **Fresh air quality**

The fresh air device operates by matching with 4-way cassette indoor unit, supplying indoor side with outdoor fresh air to improve indoor air quality and then let users enjoy the fresher air.

- **Beautiful appearance**

With a beautiful and elegant outlook, it can match with a 4-way cassette unit for operation.

## 360° Air Discharge Compact Cassette Unit

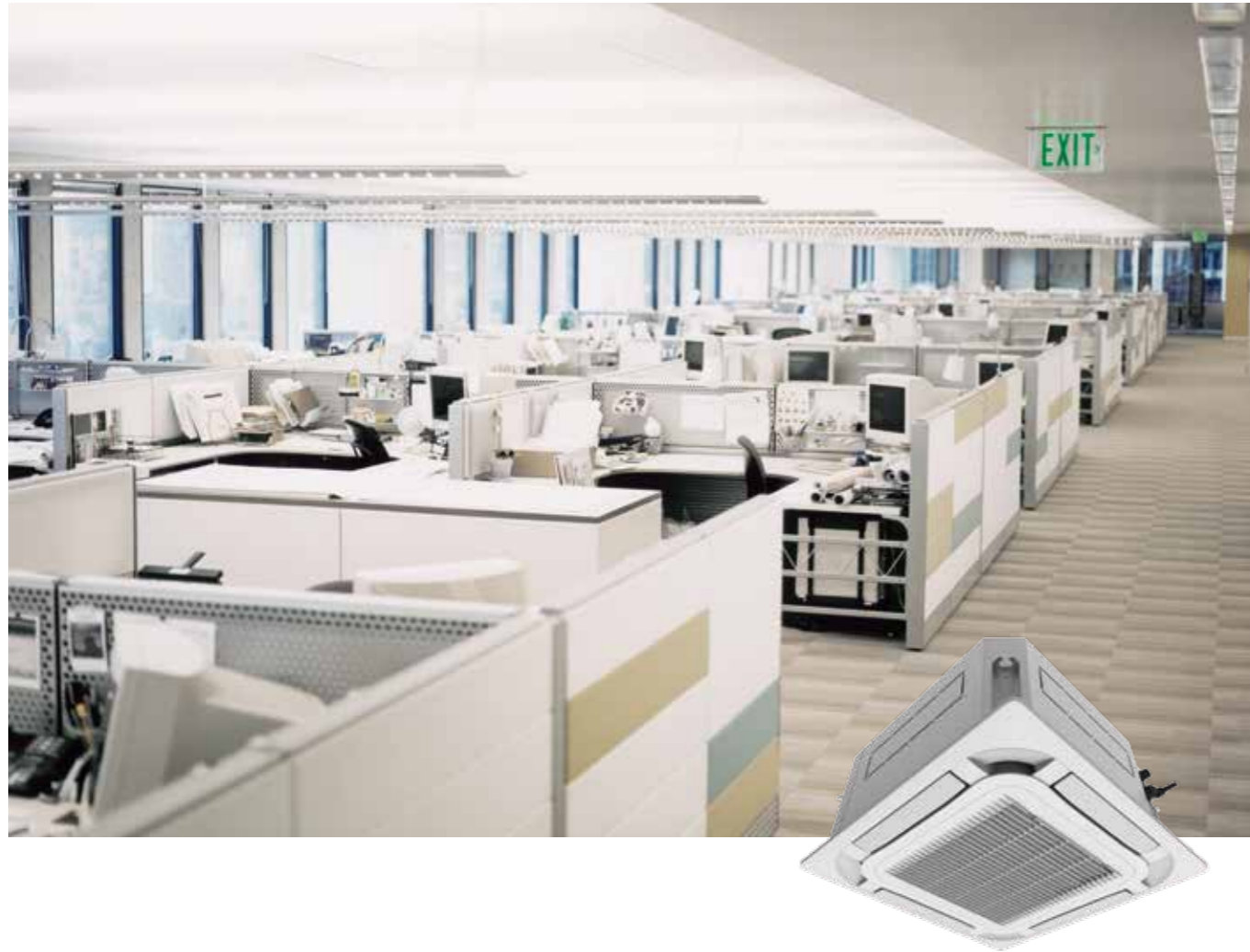

- 360° Air supply**  
 360° air supply design for wide air supply range and balanced temperature distribution, more comfortable.
- Independent swing control**  
 4 swing blades can be controlled independently; multiple air supply angle combinations are available for free and humanized control, avoiding direct air blow to people.
- New air duct and blade design for low noise**  
 Adopt new air duct and blade with fluid simulation design for lower noise; noise is as low as 25dB.
- DC quiet drainage pump**  
 The water height difference is up to 1.2m (47-2/8 inch), which can effectively drain out condensing water and save space. High-lift DC quiet type drainage pump reduces power consumption and improves sound quality; the maximum lifting height is 1200mm (47-2/8 inch); installation is more flexible and the drainage pipe layout is more convenient.

## 2-way Cassette Unit



- Beautiful appearance**  
 With beautiful and elegant front panel, it is congenial to the indoor surroundings.
- Intelligent drainage device**  
 Water height difference up to 1.2m(3-15/16ft.), which can effectively drain out condensing water and save space.
- Two-way airflow design**  
 Two-way air outlet, to stretch air outlet distance and solve air supply problem of the elongated room.
- Multiple protections**  
 Anti-freezing protection, temperature malfunction protection, fan motor overload, and humidity sensor protection.



## 1-way Cassette Indoor Unit



- **Small installation space**

With 185mm (7-1/4 in.) ultra thin design, the unit can be installed in a 19cm deep ceiling.

- **Detachable grille and long-life filter**

A grille is detachable for easy cleaning. With durable filter, the cleaning cycle is 20 times longer.

- **High drain pump lift**

Drain pump lift reaches 1.2m(3-15/16ft.), which can effectively drain out water.

- **Protection function**

Water overflow protection, anti-freezing protection, fan motor overload protection, temperature sensor malfunction protection.

## Wall-mounted Type



- **Comfortable and balanced airflow, up&down air outlet**

Up air outlet: In cooling, cool air blows out horizontally and then gradually drops.

Down air swing: In heating, warm air blows downward and then gradually climbs up.

- **Triple defenders for better purification**

Mildew-proof filter, electrostatic fiber and anti-biotic fiber adopted to remove dust, smell, bacteria and mildew.

- **Cold air prevention design**

During heating in winter, cold air prevention function is enabled so that air won't be blown out until it's warm.

- **Multiple protections**

Anti-freezing protection, temperature sensor malfunction protection, fan motor overload protection.

## Console



- **Multiple fan speed**

The fan can operate in multiple speed and satisfy different airflow volume requirements.

- **Detachable grille and long-life filter**

A grille is detachable for easy cleaning. With long life filter, the cleaning cycle is 20 times longer.

- **Protection function**

Anti-freezing protection, fan motor overload protection, temperature sensor malfunction protection.

## Floor Ceiling Type

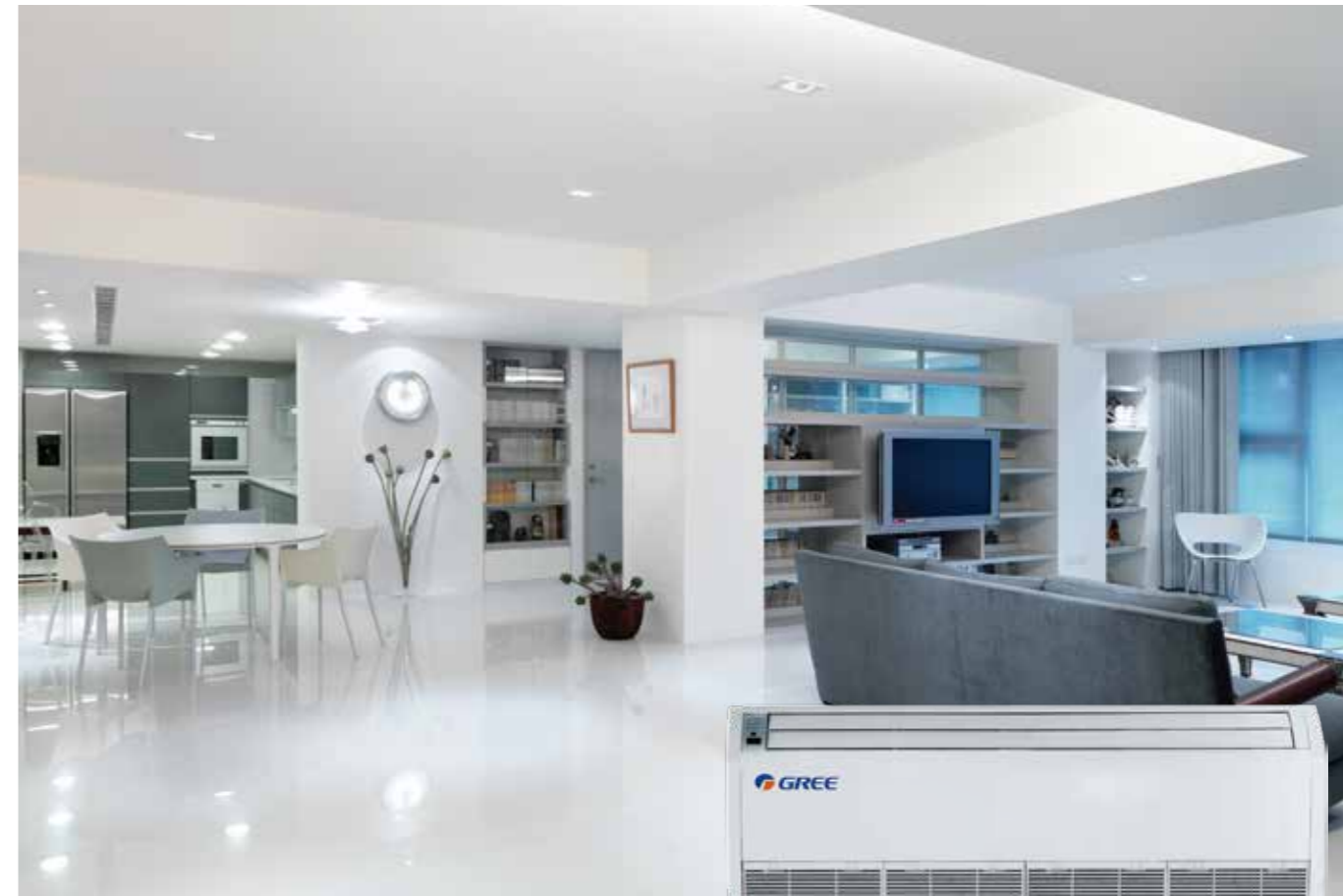

- **Ceiling or floor mounted, flexible installation**

The unit can be ceiling or floor mounted. When floor mounted, a suspended ceiling is not needed.

- **Beautiful appearance**

With beautiful and elegant front panel, it is congenial to the indoor surroundings.

- **Protection function**

Anti-freezing protection, temperature sensor malfunction protection, fan motor overload protection.

- **Horizontal and vertical air swing**

Wider air swing range for your comfortable working and living environment.

## Fresh Air Processing Unit

Airflow volume: 589~2060CFM, cooling capacity: 42~96 kBtu/h.  
Applicable to all kinds of structure.



### One system, two functions

- Adopted with DC inverter technology, Fresh Air DC Inverter Multi VRF System features air conditioning function and fresh air function.

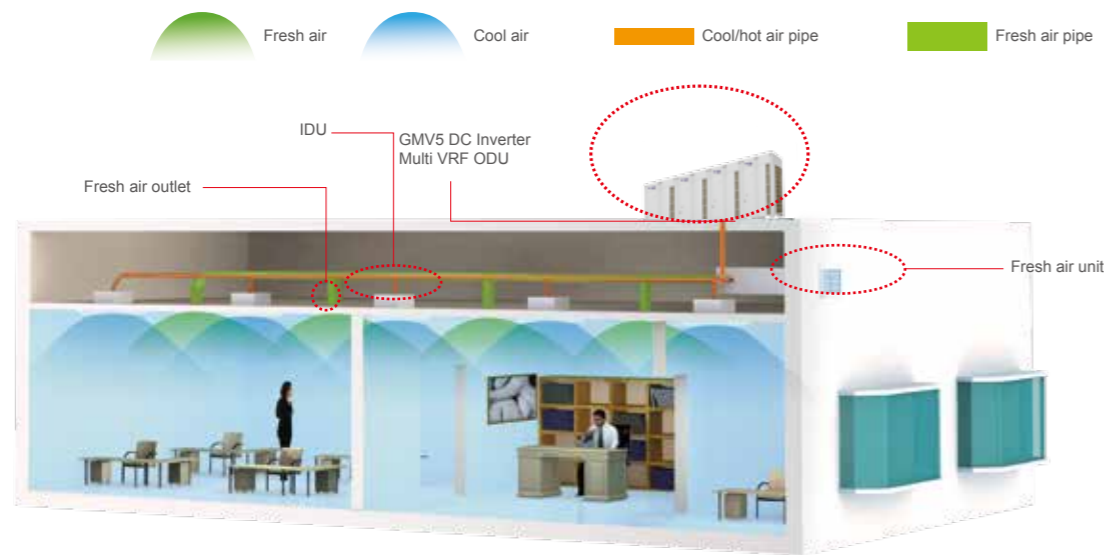

### Enjoy fresh air

- Airflow volume: 589~2060CFM, cooling capacity: 42~96 kBtu/h  
Applicable for all kinds of structure.
- Direct evaporative cooling adopted, air conditioning+fresh air can be realized accurately and precisely.
- DC inverter technology adopted, constant humidity is enabled with less power consumption.
- Integrated system control with Gree GMV Multi VRF System.



### Air conditioning and fresh air, two in one

- Less investment**  
Fresh Air DC Inverter Multi VRF System can be combined with Gree GMV5. For the same room, if the same amount of fresh air is to be taken, then the cost of GMV5+Fresh air unit is equivalent to the cost of GMV+Air exchange fan.
- Less operation cost**  
The unit can control refrigerant output according to actual needs to ensure constant airflow temperature. By adjusting power output, light-load but high power operation can be avoided. Thus, operation costs can be greatly reduced.



## Air Handler

- Highly flexible installation**  
Installation space for this unit is small, allowing easy installation and maintenance. The unit can be installed on the ground or on the roof of the building, which means the installation is totally flexible depending on the project requirement.
- Cold air prevention design**  
When heating in winter, cold air prevention function is enabled so that air won't be blown out until it's warm.
- Long life and washable filter**  
The filter is easy to be dismantled and installed. You can use a dust collector or water to clear away the dust.

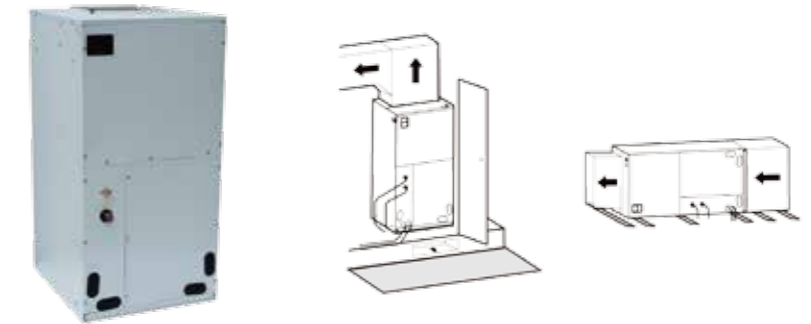

## AHU KIT

- With functions and advantages of the VRF unit.
- Multiple installation methods, convenient for project design.
- Independent design, convenient for installation.
- With a wide capacity range.
- Error signal connected, safe and reliable for operation.
- Take the outdoor unit of VRF unit as the cold and heat sources, no need extra cold and heat sources.
- Dual control methods: general indoor unit control or fresh function control for selection.
- AHU KIT can connect the third-party controller to realize many functions for the complete system, such as switchover among different modes and temperature setting.





### High Static Pressure Duct Unit\*

Model			GMV-ND18PHS/A-T(U)	GMV-ND24PHS/A-T(U)	GMV-ND30PHS/A-T(U)	GMV-ND36PHS/A-T(U)
Capacity	Cooling	Btu/h	18,000	24,000	30,000	36,000
	Heating	Btu/h	20,000	27,000	34,000	40,000
Power supply	V/Ph/Hz		208/230/1/60			
Power consumption	W		120	130	200	200
Airflow volume(H/M/L)	m <sup>3</sup> /h		1000/800/600	1100/900/700	1700/1450/1100	1700/1450/1100
	CFM		590/470/355	650/530/410	1000/855/650	1000/855/650
MCA	A		1.2	1.2	1.8	1.8
MOP	A		15	15	15	15
ESP	In.W.G		0.28/0~0.4	0.28/0~0.4	0.28/0~0.4	0.28/0~0.4
Sound pressure level(H/M/L)	dB(A)		44/40/36	45/41/37	46/44/42	46/44/42
Connecting pipe	Liquid	In.	Φ3/8	Φ3/8	Φ3/8	Φ3/8
	Gas	In.	Φ5/8	Φ5/8	Φ5/8	Φ5/8
Drain pipe	External dia.	In.	Φ1	Φ1	Φ1	Φ1
	Thickness	In.	3/32	3/32	3/32	3/32
Dimension (W×D×H)	Outline	In.	50×22×10-1/2	50×22×10-1/2	48-3/8×30-1/2×11-3/8	48-3/8×30-1/2×11-3/8
	Package	In.	53-1/16×23-3/8×11-1/8	53-1/16×23-3/8×11-1/8	52-11/16×34-1/2×12	52-11/16×34-1/2×12
Net weight/Gross weight	lbs		77/88	77/88	104/119	104/119
Loading quantity	40' GP	set	192	192	128	128
	40' HQ	set	216	216	128	128

### Super High Static Pressure Duct Unit

Model			GMV-ND07PHS/B-T(U)	GMV-ND09PHS/B-T(U)	GMV-ND12PHS/B-T(U)	GMV-ND15PHS/B-T(U)	GMV-ND18PHS/B-T(U)
Capacity	Cooling	Btu/h	7500	9500	12,000	15,000	18,000
	Heating	Btu/h	8500	10,500	13,500	17,000	20,000
Power supply	V/Ph/Hz		208/230/1/60				
Power consumption	W		66	66	42	51	106
Airflow volume(H/M/L)	m <sup>3</sup> /h		550/480/400	550/480/400	600/500/420	850/700/600	1000/800/700
	CFM		324/282/235	324/282/235	353/294/247	500/412/353	589/471/412
MCA	A		1	1	1	1	1
MOP	A		15	15	15	15	15
ESP	In.W.G		0.24/0~0.6	0.24/0~0.6	0.24/0~0.6	0.24/0~0.6	0.36/0~0.8
Sound pressure level(H/M/L)	dB(A)		35/33/31	35/33/31	36/34/32	40/37/34	42/38/35
Connecting pipe	Liquid	In.	Φ1/4	Φ1/4	Φ1/4	Φ1/4	Φ3/8
	Gas	In.	Φ3/8	Φ3/8	Φ1/2	Φ1/2	Φ5/8
Drain pipe	External dia.	In.	Φ1	Φ1	Φ1	Φ1	Φ1
	Thickness	In.	3/32	3/32	3/32	3/32	3/32
Dimension (W×D×H)	Outline	In.	27-9/16×27-9/16×11-13/16	27-9/16×27-9/16×11-13/16	39-3/8×27-9/16×11-13/16	39-3/8×27-9/16×11-13/16	39-3/8×27-9/16×11-13/16
	Package	In.	35-5/16×32×14-3/16	35-5/16×32×14-3/16	47-7/16×32×14-3/16	47-7/16×32×14-3/16	47-7/16×32×14-3/16
Net weight/Gross weight	lbs		73/86	73/86	94/108	94/108	94/108
Loading quantity	40' GP	set	168	168	138	138	138
	40' HQ	set	196	196	161	161	161

Model			GMV-ND42PHS/A-T(U)	GMV-ND48PHS/A-T(U)	GMV-ND72PHS/A-T(U)	GMV-ND96PHS/A-T(U)
Capacity	Cooling	Btu/h	42,000	48,000	69,000	92,000
	Heating	Btu/h	47,000	54,000	77,000	103,000
Power supply	V/Ph/Hz		208/230/1/60			
Power consumption	W		220	220	800	900
Airflow volume(H/M/L)	m <sup>3</sup> /h		2000/1550/1200	2000/1700/1400	4000/3600/3200	4400/4000/3600
	CFM		1180/910/705	1180/1000/825	2355/2120/1885	2590/2355/2120
MCA	A		2	2	6.3	7.5
MOP	A		15	15	15	15
ESP	In.W.G		0.28/0~0.4	0.28/0~0.4	0.4/0.2~0.8	0.4/0.2~0.8
Sound pressure level(H/M/L)	dB(A)		48/45/42	48/46/44	54/52/49	55/52/50
Connecting pipe	Liquid	In.	Φ3/8	Φ3/8	Φ3/8	Φ3/8
	Gas	In.	Φ5/8	Φ5/8	Φ3/4	Φ7/8
Drain pipe	External dia.	In.	Φ1	Φ1	Φ1	Φ1
	Thickness	In.	3/32	3/32	1/16	1/16
Dimension (W×D×H)	Outline	In.	48-3/8×30-1/2×11-3/8	48-3/8×30-1/2×11-3/8	58-3/8×31-1/8×15-3/16	66-3/8×34-1/4×17-3/4
	Package	In.	52-11/16×34-1/2×12	52-11/16×34-1/2×12	62-1/8×34-3/4×18-5/8	70-3/8×38-7/8×22-7/8
Net weight/Gross weight	lbs		104/119	104/119	181/229	232/309
Loading quantity	40' GP	set	128	128	52	52
	40' HQ	set	128	128	65	52

Model			GMV-ND22PHS/B-T(U)	GMV-ND24PHS/B-T(U)	GMV-ND30PHS/B-T(U)	GMV-ND36PHS/B-T(U)	GMV-ND42PHS/B-T(U)
Capacity	Cooling	Btu/h	22,000	24,000	30,000	36,000	42,000
	Heating	Btu/h	24,000	27,000	34,000	40,000	47,000
Power supply	V/Ph/Hz		208/230/1/60				
Power consumption	W		106	133	262	262	262
Airflow volume(H/M/L)	m <sup>3</sup> /h		1000/800/700	1250/1050/950	1800/1450/1250	2000/1600/1400	2000/1600/1400
	CFM		589/471/412	736/618/559	1059/853/736	1177/942/824	1177/942/824
MCA	A		1	1.2	1.7	1.7	1.7
MOP	A		15	15	15	15	15
ESP	In.W.G		0.36/0~0.8	0.36/0~0.8	0.36/0~0.8	0.36/0~0.8	0.36/0~0.8
Sound pressure level(H/M/L)	dB(A)		42/38/35	43/39/35	44/41/38	45/42/40	45/42/40
Connecting pipe	Liquid	In.	Φ3/8	Φ3/8	Φ3/8	Φ3/8	Φ3/8
	Gas	In.	Φ5/8	Φ5/8	Φ5/8	Φ5/8	Φ5/8
Drain pipe	External dia.	In.	Φ1	Φ1	Φ1	Φ1	Φ1
	Thickness	In.	3/32	3/32	3/32	3/32	3/32
Dimension (W×D×H)	Outline	In.	39-3/8×27-9/16×11-13/16	39-3/8×27-9/16×11-13/16	55-1/8×27-9/16×11-13/16	55-1/8×27-9/16×11-13/16	55-1/8×27-9/16×11-13/16
	Package	In.	47-7/16×32×14-3/16	47-7/16×32×14-3/16	63-1/16×32×14-3/8	63-1/16×32×14-3/8	63-1/16×32×14-3/8
Net weight/Gross weight	lbs		94/108	94/108	121/137	121/137	121/137
Loading quantity	40' GP	set	138	138	84	84	84
	40' HQ	set	161	161	98	98	98

\*Note: This series will be phased out during 2020.



Model			GMV-ND48PHS/B-T(U)	GMV-ND54PHS/B-T(U)	GMV-ND72PH/B-T(U)	GMV-ND96PH/B-T(U)
Capacity	Cooling	Btu/h	48,000	54,000	72,000	96,000
	Heating	Btu/h	54,000	60,000	81,000	108,000
Power supply	V/Ph/Hz		208/230/1/60			
Power consumption	W		287	287	530	670
Airflow volume(H/M/L)	m³/h		2350/1900/1650	2500/2000/1750	4000/3200/2800	4300/3600/3200
	CFM		1383/1118/971	1471/1177/1030	2355/1885/1650	2530/2120/1885
MCA	A		1.7	1.7	5.7	6.8
MOP	A		15	15	15	15
ESP	In.W.G		0.36/0-0.8	0.36/0-0.8	0.52/0.2-0.98	0.6/0.2-1.10
Sound pressure level(H/M/L)	dB(A)		46/43/41	47/44/42	46/45/44	48/46/45
Connecting pipe	Liquid	In.	Φ3/8	Φ3/8	Φ3/8	Φ3/8
	Gas	In.	Φ5/8	Φ3/4	Φ3/4	Φ7/8
Drain pipe	External dia.	In.	Φ1	Φ1	Φ1	Φ1
	Thickness	In.	3/32	3/32	1/16	1/16
Dimension (W×D×H)	Outline	In.	55-1/8×27-9/16×11-13/16	55-1/8×27-9/16×11-13/16	48-3/4×41×18-1/2	48-3/4×41×18-1/2
	Package	In.	66-1/16×32×14-3/8	66-1/16×32×14-3/8	59-7/8×45-3/8×23-7/8	59-7/8×45-3/8×23-7/8
Net weight/Gross weight	lbs		128/148	128/148	223/331	236/340
Loading quantity	40' GP	set	84	84	45	45
	40' HQ	set	98	98	60	60

### Medium Static Pressure Duct Unit

Model			GMV-ND30PLS/C-T(U)	GMV-ND36PLS/C-T(U)	GMV-ND42PLS/C-T(U)	GMV-ND48PLS/C-T(U)
Capacity	Cooling	Btu/h	30,000	36,000	42,000	48,000
	Heating	Btu/h	34,000	40,000	47,000	54,000
Power supply	V/Ph/Hz		208/230/1/60			
Power Input	W		130	130	170	170
Airflow volume ( H/M/L )	m³/h		1500/1250/900	1700/1500/1100	2000/1700/1400	2000/1700/1400
	CFM		880/735/530	1000/880/650	1180/1000/825	1180/1000/825
MCA	A		3.0	3.0	3.0	3.0
MOP	A		15	15	15	15
ESP	In.W.G		0.2	0.2	0.2	0.2
Sound pressure level(H/M/L)	dB(A)		40/36/32	40/36/32	42/40/37	42/40/37
Connecting pipe diameter	Liquid	In.	Φ3/8	Φ3/8	Φ3/8	Φ3/8
	Gas	In.	Φ5/8	Φ5/8	Φ5/8	Φ5/8
Drain pipe	External dia.	In.	Φ1	Φ1	Φ1	Φ1
	Thickness	In.	3/32	3/32	3/32	3/32
Dimension (W×D×H)	Outline	In.	52-3/4×25-13/16×10-1/4	52-3/4×25-13/16×10-1/4	52-3/4×25-13/16×10-1/4	52-3/4×25-13/16×10-1/4
	Package	In.	62-1/2×33-3/4×12-3/8	62-1/2×33-3/4×12-3/8	62-1/2×33-3/4×12-3/8	62-1/2×33-3/4×12-3/8
Net weight/Gross weight	lbs		100/120	100/120	102/122	102/122
Loading quantity	40' GP	set	105	105	105	105
	40' HQ	set	120	120	120	120

### Low Static Pressure Duct Unit

Model			GMV-ND07PLS/A-T(U)	GMV-ND09PLS/A-T(U)	GMV-ND12PLS/A-T(U)	GMV-ND14PLS/A-T(U)	GMV-ND18PLS/A-T(U)	GMV-ND22PLS/A-T(U)
Capacity	Cooling	Btu/h	7500	9500	12,000	15,000	18,000	24,000
	Heating	Btu/h	8500	10,500	13,500	17,000	20,000	27,000
Power supply	V/Ph/Hz		208/230/1/60					
Power consumption	W		43	43	43	52	99	99
Airflow volume (H/M/L)	m³/h		450/400/250	450/400/250	550/450/350	700/600/450	1000/800/600	1000/800/600
	CFM		265/235/147	265/235/147	324/265/206	412/353/265	589/471/353	589/471/353
Rated current	Cooling	A	0.3	0.3	0.3	0.5	0.7	0.7
	Heating	A	0.3	0.3	0.3	0.5	0.7	0.7
MCA	A		1	1	1	1	1	
MOP	A		15	15	15	15	15	
ESP	In.W.G		0.06/0-0.12	0.06/0-0.12	0.06/0-0.12	0.06/0-0.12	0.06/0-0.12	0.06/0-0.12
Sound pressure level(H/M/L)	dB(A)		31/29/25	31/29/25	32/30/27	33/31/28	35/33/30	35/33/30
Connecting pipe	Liquid	In.	Φ1/4	Φ1/4	Φ1/4	Φ1/4	Φ3/8	Φ3/8
	Gas	In.	Φ3/8	Φ3/8	Φ1/2	Φ1/2	Φ5/8	Φ5/8
Drain pipe	External dia.	In.	Φ1	Φ1	Φ1	Φ1	Φ1	Φ1
	Thickness	In.	3/32	3/32	3/32	3/32	3/32	3/32
Dimension (W×D×H)	Outline	In.	27-9/16×24-3/16×7-7/8	27-9/16×24-3/16×7-7/8	27-9/16×24-3/16×7-7/8	35-7/16×24-3/16×7-7/8	43-5/16×24-3/16×7-7/8	43-5/16×24-3/16×7-7/8
	Package	In.	35-3/16×29-1/4×12	35-3/16×29-1/4×12	35-3/16×29-1/4×12	44-3/16×29-1/4×12	52-1/16×29-1/4×12	52-1/16×29-1/4×12
Net weight/Gross weight	lbs		51/64	51/64	51/64	60/73	69/86	69/86
Loading quantity	40'GP	set	192	192	192	192	162	162
	40'HQ	set	192	192	192	192	162	162

Note: This series will be phased out during 2020.

Model			GMV-ND07PLS/B1-T(U)	GMV-ND09PLS/B1-T(U)	GMV-ND12PLS/B1-T(U)	GMV-ND14PLS/B1-T(U)	GMV-ND18PLS/B1-T(U)	GMV-ND24PLS/B1-T(U)
Capacity	Cooling	Btu/h	7500	9500	12,000	15,000	18,000	24,000
	Heating	Btu/h	8500	10,500	13,500	17,000	20,000	27,000
Power supply	V/Ph/Hz		208/230/1/60					
Power consumption	W		28	28	37	40	55	55
Airflow volume (H/M/L)	m³/h		450/350/200	450/350/200	550/400/300	750/550/400	850/700/550	1100/850/650
	CFM		265/206/118	265/206/118	324/235/177	441/324/235	500/412/324	647/500/383
MCA	A		1	1	1	1	1	
MOP	A		15	15	15	15	15	
ESP	In.W.G		0.06/0-0.12	0.06/0-0.12	0.06/0-0.12	0.06/0-0.12	0.06/0-0.12	0.06/0-0.12
Sound pressure level(H/M/L)	dB(A)		30/25/22	30/25/22	31/27/25	33/29/27	35/31/29	37/32/30
Connecting pipe	Liquid	In.	Φ1/4	Φ1/4	Φ1/4	Φ1/4	Φ3/8	Φ3/8
	Gas	In.	Φ3/8	Φ3/8	Φ1/2	Φ1/2	Φ5/8	Φ5/8
Drain pipe	External dia.	In.	Φ1	Φ1	Φ1	Φ1	Φ1	
	Thickness	In.	3/32	3/32	3/32	3/32	3/32	
Dimension (W×D×H)	Outline	In.	27-15/16×18-3/16×7-14/16	27-15/16×18-3/16×7-14/16	27-15/16×18-3/16×7-14/16	39-12/16×18-3/16×7-14/16	39-12/16×18-3/16×7-14/16	51-9/16×18-3/16×7-14/16
	Package	In.	40-4/16×22-5/16×10-10/16	40-4/16×22-5/16×10-10/16	40-4/16×22-5/16×10-10/16	52-1/16×22-5/16×10-10/16	52-1/16×22-5/16×10-10/16	64×22-5/16×10-10/16
Net weight/Gross weight	lbs		40.8/51.8	40.8/51.8	41.9/52.9	55.1/68.4	55.1/68.4	68.4/82.7
Loading quantity	40'GP	set	352	352	352	272	272	224
	40'HQ	set	396	396	396	306	306	252

Model			GMV-ND07PLS/B-T(U)*	GMV-ND09PLS/B-T(U)*	GMV-ND12PLS/B-T(U)*	GMV-ND14PLS/B-T(U)*	GMV-ND18PLS/B-T(U)*	GMV-ND24PLS/B-T(U)*
Capacity	Cooling	Btu/h	7500	9500	12,000	15,000	18,000	24,000
	Heating	Btu/h	8500	10,500	13,500	17,000	20,000	27,000
Power supply	V/Ph/Hz		208/230/1/60					
Power consumption	W		28	28	37	40	55	55
Airflow volume (H/M/L)	m³/h		450/350/200	450/350/200	550/400/300	750/550/400	850/700/550	1100/850/650
	CFM		265/206/118	265/206/118	324/235/177	441/324/235	500/412/324	647/500/383
MCA	A		1	1	1	1	1	
MOP	A		15	15	15	15	15	
ESP	In.W.G		0.06/0-0.12	0.06/0-0.12	0.06/0-0.12	0.06/0-0.12	0.06/0-0.12	0.06/0-0.12
Sound pressure level(H/M/L)	dB(A)		30/25/22	30/25/22	31/27/25	33/29/27	35/31/29	37/32/30
Connecting pipe	Liquid	In.	Φ1/4	Φ1/4	Φ1/4	Φ1/4	Φ3/8	Φ3/8
	Gas	In.	Φ3/8	Φ3/8	Φ1/2	Φ1/2	Φ5/8	Φ5/8
Drain pipe	External dia.	In.	Φ1	Φ1	Φ1	Φ1	Φ1	
	Thickness	In.	3/32	3/32	3/32	3/32	3/32	
Dimension (W×D×H)	Outline	In.	27-15/16×18-3/16×7-14/16	27-15/16×18-3/16×7-14/16	27-15/16×18-3/16×7-14/16	39-12/16×18-3/16×7-14/16	39-12/16×18-3/16×7-14/16	51-9/16×18-3/16×7-14/16
	Package	In.	40-4/16×22-5/16×10-10/16	40-4/16×22-5/16×10-10/16	40-4/16×22-5/16×10-10/16	52-1/16×22-5/16×10-10/16	52-1/16×22-5/16×10-10/16	64×22-5/16×10-10/16
Net weight/Gross weight	lbs		40.8/51.8	40.8/51.8	41.9/52.9	55.1/68.4	55.1/68.4	68.4/82.7
Loading quantity	40'GP	set	352	352	352	272	272	224
	40'HQ	set	396	396	396	306	306	252

\*Note: The connecting pipe of this model is on the right side.

### 4-Way Cassette Unit\*

Model			GMV-ND07T/A-T(U)	GMV-ND09T/A-T(U)	GMV-ND12T/A-T(U)	GMV-ND15T/A-T(U)	GMV-ND18T/A-T(U)
Capacity	Cooling	Btu/h	7500	9500	12,000	15,000	18,000
	Heating	Btu/h	8500	10,500	13,500	17,000	20,000
Power supply	V/Ph/Hz		208/230/1/60				
Power consumption	W		48	59	59	59	59
Airflow volume(H/M/L)	m <sup>3</sup> /h		750/650/550	1000/900/750	1000/900/750	1000/900/750	1000/900/750
	CFM		440/385/325	590/530/440	590/530/440	590/530/440	590/530/440
MCA	A		1	1	1	1	1
MOP	A		15	15	15	15	15
Sound pressure level(H/M/L)	dB(A)		36/34/31	37/35/32	37/35/32	37/35/32	37/35/32
Connecting pipe	Liquid	In.	Φ1/4	Φ1/4	Φ1/4	Φ1/4	Φ3/8
	Gas	In.	Φ3/8	Φ3/8	Φ1/2	Φ1/2	Φ5/8
Drain pipe	External dia.	In.	Φ1	Φ1	Φ1	Φ1	Φ1
	Thickness	In.	3/32	3/32	3/32	3/32	3/32
Main body	Dimension (W×D×H)	Outline	In.	33×33×7-1/2	33×33×9-1/2	33×33×9-1/2	33×33×9-1/2
		Package	In.	37-15/16×37-15/16×10-11/16	37-15/16×37-15/16×12-13/16	37-15/16×37-15/16×12-13/16	37-15/16×37-15/16×12-13/16
	Net weight/Gross weight		lbs	50/64	58/75	58/75	58/75
Panel	Dimension (W×D×H)	Outline	In.	37-3/8×37-3/8×2-1/2	37-3/8×37-3/8×2-1/2	37-3/8×37-3/8×2-1/2	37-3/8×37-3/8×2-1/2
		Package	In.	40-11/16×40-7/8×5-1/4	40-11/16×40-7/8×5-1/4	40-11/16×40-7/8×5-1/4	40-11/16×40-7/8×5-1/4
	Net weight/Gross weight		lbs	15/24	15/24	15/24	15/24
Loading quantity	40' GP	set	167	140	140	140	140
	40' HQ	set	171	156	156	156	156

Model			GMV-ND24T/A-T(U)	GMV-ND30T/A-T(U)	GMV-ND36T/A-T(U)	GMV-ND42T/A-T(U)	GMV-ND48T/A-T(U)
Capacity	Cooling	Btu/h	24,000	30,000	36,000	42,000	48,000
	Heating	Btu/h	27,000	34,000	40,000	47,000	54,000
Power supply	V/Ph/Hz		208/230/1/60				
Power consumption	W		68	98	110	110	110
Airflow volume(H/M/L)	m <sup>3</sup> /h		1180/1000/800	1500/1350/1100	1700/1400/1100	1860/1500/1150	1860/1500/1150
	CFM		695/590/470	885/795/650	1000/825/650	1095/885/680	1095/885/680
MCA	A		1	1	1	1	1
MOP	A		15	15	15	15	15
Sound pressure level(H/M/L)	dB(A)		38/36/33	40/38/35	41/38/36	43/41/38	43/41/38
Connecting pipe	Liquid	In.	Φ3/8	Φ3/8	Φ3/8	Φ3/8	Φ3/8
	Gas	In.	Φ5/8	Φ5/8	Φ5/8	Φ5/8	Φ5/8
Drain pipe	External dia.	In.	Φ1	Φ1	Φ1	Φ1	Φ1
	Thickness	In.	3/32	3/32	3/32	3/32	3/32
Main body	Dimension (W×D×H)	Outline	In.	33×33×9-1/2	33×33×12-5/8	33×33×12-5/8	33×33×12-5/8
		Package	In.	37-15/16×37-15/16×12-13/16	37-15/16×37-15/16×16-1/8	37-15/16×37-15/16×16-1/8	37-15/16×37-15/16×16-1/8
	Net weight/Gross weight		lbs	58/75	72/88	72/88	72/88
Panel	Dimension (W×D×H)	Outline	In.	37-3/8×37-3/8×2-1/2	37-3/8×37-3/8×2-1/2	37-3/8×37-3/8×2-1/2	37-3/8×37-3/8×2-1/2
		Package	In.	40-11/16×40-7/8×5-1/4	40-11/16×40-7/8×5-1/4	40-11/16×40-7/8×5-1/4	40-11/16×40-7/8×5-1/4
	Net weight/Gross weight		lbs	15/24	15/24	15/24	15/24
Loading quantity	40' GP	set	140	104	104	104	104
	40' HQ	set	156	119	119	119	119

\*Note: This series will be phased out during 2020.

### 360° Air Discharge Cassette Indoor Unit

Model			GMV-ND07T/C-T(U)	GMV-ND09T/C-T(U)	GMV-ND12T/C-T(U)	GMV-ND15T/C-T(U)	GMV-ND18T/C-T(U)
Capacity	Cooling	Btu/h	7500	9500	12000	15000	18000
	Heating	Btu/h	8500	10500	13500	17000	20000
Power supply	V/Ph/Hz		208/230/1/60	208/230/1/60	208/230/1/60	208/230/1/60	208/230/1/60
Power consumption	W		26	26	26	26	35
Airflow volume(H/M/L)	m <sup>3</sup> /h		800/700/600	800/700/600	800/700/600	800/700/600	950/850/750
	CFM		471/412/353	471/412/353	471/412/353	471/412/353	559/500/441
Rated current	Cooling	A	0.2	0.2	0.2	0.2	0.2
	Heating	A	0.2	0.2	0.2	0.2	0.2
MCA	A		1	1	1	1	1
MOP	A		15	15	15	15	15
Sound pressure level(H/M/L)	dB(A)		33/30/28	33/30/28	33/30/28	33/30/28	36/33/30
Connecting pipe	Liquid	In.	Φ 1/4	Φ 1/4	Φ 1/4	Φ 1/4	Φ 3/8
	Gas	In.	Φ 3/8	Φ 3/8	Φ 1/2	Φ 1/2	Φ 5/8
Drain pipe	External dia.	In.	Φ 1	Φ 1	Φ 1	Φ 1	Φ 1
	Thickness	In.	3/32	3/32	3/32	3/32	3/32
Main body	Dimension (W×D×H)	Outline	In.	33-1/8×33-1/8×9-1/2	33-1/8×33-1/8×9-1/2	33-1/8×33-1/8×9-1/2	33-1/8×33-1/8×9-1/2
		Package	In.	37-7/8×37-7/8×12-3/4	37-7/8×37-7/8×12-3/4	37-7/8×37-7/8×12-3/4	37-7/8×37-7/8×12-3/4
	Net weight/Gross weight		lbs	61.7/79.4	61.7/79.4	61.7/79.4	63.9/81.6
Panel	Dimension (W×D×H)	Outline	In.	37-3/8×37-3/8×2-1/2	37-3/8×37-3/8×2-1/2	37-3/8×37-3/8×2-1/2	37-3/8×37-3/8×2-1/2
		Package	In.	40-7/8×40-5/8×4-3/8	40-7/8×40-5/8×4-3/8	40-7/8×40-5/8×4-3/8	40-7/8×40-5/8×4-3/8
	Net weight/Gross weight		lbs	13.2/20.9	13.2/20.9	13.2/20.9	13.2/20.9
Loading quantity	40' GP	set	120	120	120	120	120
	40' HQ	set	140	140	140	140	140

Model			GMV-ND22T/C-T(U)	GMV-ND24T/C-T(U)	GMV-ND30T/C-T(U)	GMV-ND36T/C-T(U)	GMV-ND42T/C-T(U)	GMV-ND48/C-T(U)
Capacity	Cooling	Btu/h	22000	24000	30000	36000	42000	48000
	Heating	Btu/h	24000	27000	34000	40000	47000	54000
Power supply	V/Ph/Hz		208/230/1/60	208/230/1/60	208/230/1/60	208/230/1/60	208/230/1/60	208/230/1/60
Power consumption	W		35	60	68	80	95	115
Airflow volume(H/M/L)	m <sup>3</sup> /h		950/850/750	1150/950/850	1250/1000/900	1500/1200/1000	1650/1300/1100	1650/1300/1100
	CFM		559/500/441	677/559/500	736/589/530	883/706/589	971/765/647	971/765/647
Rated current	Cooling	A	0.2	0.4	0.4	0.4	0.5	0.6
	Heating	A	0.2	0.4	0.4	0.4	0.5	0.6
MCA	A		1	1	1	1	1	1
MOP	A		15	15	15	15	15	15
Sound pressure level(H/M/L)	dB(A)		36/33/30	37/34/31	39/37/34	41/39/37	43/41/39	43/41/39
Connecting pipe	Liquid	In.	Φ 3/8	Φ 3/8	Φ 3/8	Φ 3/8	Φ 3/8	Φ 3/8
	Gas	In.	Φ 5/8	Φ 5/8	Φ 5/8	Φ 5/8	Φ 5/8	Φ 5/8
Drain pipe	External dia.	In.	Φ 1	Φ 1	Φ 1	Φ 1	Φ 1	Φ 1
	Thickness	In.	3/32	3/32	3/32	3/32	3/32	3/32
Main body	Dimension (W×D×H)	Outline	In.	33-1/8×33-1/8×9-1/2	33-1/8×33-1/8×9-1/2	33-1/8×33-1/8×11-3/8	33-1/8×33-1/8×11-3/8	33-1/8×33-1/8×11-3/8
		Package	In.	37-7/8×37-7/8×12-3/4	37-7/8×37-7/8×12-3/4	37-7/8×37-7/8×14-7/8	37-7/8×37-7/8×14-7/8	37-7/8×37-7/8×14-7/8
	Net weight/Gross weight		lbs	63.9/81.6	63.9/81.6	68.4/83.8	77.2/97	77.2/97
Panel	Dimension (W×D×H)	Outline	In.	37-3/8×37-3/8×2-1/2	37-3/8×37-3/8×2-1/2	37-3/8×37-3/8×2-1/2	37-3/8×37-3/8×2-1/2	37-3/8×37-3/8×2-1/2
		Package	In.	40-7/8×40-5/8×4-3/8	40-7/8×40-5/8×4-3/8	40-7/8×40-5/8×4-3/8	40-7/8×40-5/8×4-3/8	40-7/8×40-5/8×4-3/8
	Net weight/Gross weight		lbs	13.2/20.9	13.2/20.9	13.2/20.9	13.2/20.9	13.2/20.9
Loading quantity	40' GP	set	120	120	120	120	120	120
	40' HQ	set	140	140	140	140	140	140

## Fresh Air Ventilation Kit

Model	-	XF150A-T <sup>1</sup>	XF150A1-T <sup>2</sup>
Fresh air intake volume	%	10%	10%
Dimension (W×D×H)	Outline	In. 32-7/8×32-7/8×2-3/8	33-5/16×33-3/4×2-3/8
	Package	In. 34-9/16×34-9/16×7-3/32	34-9/16×34-9/16×7-3/32
Dimension of the connection	In.	5-11/16	5-11/16
	Pcs	2	2
Net weight/Gross weight	lbs	6.0/17.0	6.6/15.7

Note:  
<sup>1</sup>: This model can be matched with 360° air discharge cassette indoor units of GMV-ND\*\*T/C-T(U) series only.  
<sup>2</sup>: This model can be matched with 4-way cassette indoor units of GMV-ND\*\*T/A-T(U) series only.

## 360° Air Discharge Compact Cassette Unit

Model		GMV-ND05T/E-T(U)*	GMV-ND07T/E-T(U)*	GMV-ND09T/E-T(U)*	GMV-ND12T/E-T(U)*	GMV-ND15T/E-T(U)*	GMV-ND18T/E-T(U)*	
Capacity	Cooling	Btu/h 5800	7500	9500	12,000	15,000	18,000	
	Heating	Btu/h 6200	8500	10,500	13,500	17,000	20,000	
Power supply	V/Ph/Hz	208-230V ~ 60						
Power Input	W	35	35	35	46	46	46	
Airflow volume(H/M/L)	m³/h	460/420/370	500/460/370	570/480/420	620/550/480	730/650/560	730/650/560	
	CFM	270/250/220	295/270/220	335/280/250	365/325/280	430/385/330	430/385/330	
MCA	A	0.7	0.7	0.7	0.8	0.8	0.8	
MOP	A	15	15	15	15	15	15	
Sound pressure level(H/M/L)	dB(A)	33/30/25	36/31/25	36/33/28	39/37/35	43/41/39	43/41/39	
Connecting pipe diameter	Liquid	In. Φ1/4	Φ1/4	Φ1/4	Φ1/4	Φ1/4	Φ3/8	
	Gas	In. Φ3/8	Φ3/8	Φ3/8	Φ1/2	Φ1/2	Φ5/8	
Drain pipe	External dia.	In. Φ25	Φ25	Φ25	Φ25	Φ25	Φ25	
	Thickness	In. 3/32	3/32	3/32	3/32	3/32	3/32	
Main body	Dimension (W×D×H)	Outline	In. 22-7/16×22-7/16×10-7/16	22-7/16×22-7/16×10-7/16	22-7/16×22-7/16×10-7/16	22-7/16×22-7/16×10-7/16	22-7/16×22-7/16×10-7/16	22-7/16×22-7/16×10-7/16
		Package	In. 27-1/2×25-11/16×11-5/8	27-1/2×25-11/16×11-5/8	27-1/2×25-11/16×11-5/8	27-1/2×25-11/16×11-5/8	27-1/2×25-11/16×11-5/8	27-1/2×25-11/16×11-5/8
	Net weight/Gross weight	lbs	38.6/49.6	38.6/49.6	38.6/49.6	38.6/49.6	38.6/49.6	38.6/49.6
Panel	Dimension (W×D×H)	Outline	In. 24-3/8×24-3/8×1-7/8	24-3/8×24-3/8×1-7/8	24-3/8×24-3/8×1-7/8	24-3/8×24-3/8×1-7/8	24-3/8×24-3/8×1-7/8	24-3/8×24-3/8×1-7/8
		Package	In. 27-5/8×27-5/8×5	27-5/8×27-5/8×5	27-5/8×27-5/8×5	27-5/8×27-5/8×5	27-5/8×27-5/8×5	27-5/8×27-5/8×5
	Net weight/Gross weight	lbs	6.6/10	6.6/10	6.6/10	6.6/10	6.6/10	6.6/10
Loading quantity	40' GP	set	378	378	378	378	378	
	40' HQ	set	432	432	432	432	432	

\*Note: This product is under development. Gree reserves the right to modify the specifications without prior notice.

## 2-Way Cassette Unit

Model		GMV-ND09TS/A-T(U)	GMV-ND12TS/A-T(U)	GMV-ND15TS/A-T(U)	GMV-ND18TS/A-T(U)	GMV-ND24TS/A-T(U)	
Capacity	Cooling	Btu/h 9500	12,000	15,000	18,000	24,000	
	Heating	Btu/h 10,500	13,500	17,000	20,000	27,000	
Power supply	V/Ph/Hz	208/230/1/60					
Power consumption	W	55	55	55	55	91	
Airflow volume(H/M/L)	m³/h	830/600/530	830/600/530	830/600/530	830/600/530	1100/820/760	
	CFM	490/355/312	490/355/312	490/355/312	490/355/312	650/483/448	
MCA	A	1	1	1	1	1	
MOP	A	15	15	15	15	15	
Sound pressure level(H/M/L)	dB(A)	35/33/31	35/33/31	35/33/31	35/33/31	39/37/35	
Connecting pipe	Liquid	In. Φ1/4	Φ1/4	Φ1/4	Φ3/8	Φ3/8	
	Gas	In. Φ3/8	Φ1/2	Φ1/2	Φ5/8	Φ5/8	
Drain pipe	External dia.	In. Φ1	Φ1	Φ1	Φ1	Φ1	
	Thickness	In. 3/32	3/32	3/32	3/32	3/32	
Main body	Dimension (W×D×H)	Outline	In. 47-1/4×20-1/2×13-3/8	47-1/4×20-1/2×13-3/8	47-1/4×20-1/2×13-3/8	47-1/4×20-1/2×13-3/8	47-1/4×20-1/2×13-3/8
		Package	In. 60×26×17	60×26×17	60×26×17	60×26×17	60×26×17
	Net weight/Gross weight	lbs	95/119	95/119	95/119	95/119	101/123
Panel	Dimension (W×D×H)	Outline	In. 55-3/4×24-13/16×1-1/4	55-3/4×24-13/16×1-1/4	55-3/4×24-13/16×1-1/4	55-3/4×24-13/16×1-1/4	55-3/4×24-13/16×1-1/4
		Package	In. 62-1/8×30-1/4×4-11/16	62-1/8×30-1/4×4-11/16	62-1/8×30-1/4×4-11/16	62-1/8×30-1/4×4-11/16	62-1/8×30-1/4×4-11/16
	Net weight/Gross weight	lbs	15/24	15/24	15/24	15/24	15/24
Loading quantity	40' GP	set	90	90	90	90	
	40' HQ	set	105	105	105	105	

## 1-Way Cassette Unit

Model		GMV-ND07TD/A-T(U)	GMV-ND09TD/A-T(U)	GMV-ND12TD/A-T(U)	
Capacity	Cooling	Btu/h 7500	9500	12,000	
	Heating	Btu/h 8500	10,500	13,500	
Power supply	V/Ph/Hz	208/230/1/60			
Power consumption	W	30	30	30	
Airflow volume(H/M/L)	m³/h	600/500/450	600/500/450	600/500/450	
	CFM	353/294/265	353/294/265	353/294/265	
MCA	A	0.375	0.375	0.375	
MOP	A	15	15	15	
Sound pressure level(H/M/L)	dB(A)	36/32/28	36/32/28	36/32/28	
Connecting pipe	Liquid	In. Φ1/4	Φ1/4	Φ1/4	
	Gas	In. Φ3/8	Φ3/8	Φ1/2	
Drain pipe	External dia.	In. Φ1	Φ1	Φ1	
	Thickness	In. 3/32	3/32	3/32	
Main body	Dimension (W×D×H)	Outline	In. 38-7/8×15-3/16×7	38-7/8×15-3/16×7	38-7/8×15-3/16×7
		Package	In. 51-1/2×19-3/4×12-3/16	51-1/2×19-3/4×12-3/16	51-1/2×19-3/4×12-3/16
	Net weight/Gross weight	lbs	44/60	44/60	44/60
Panel	Dimension (W×D×H)	Outline	In. 47-1/4×18-1/8×2-3/16	47-1/4×18-1/8×2-3/16	47-1/4×18-1/8×2-3/16
		Package	In. 49-13/16×21-1/8×4-3/4	49-13/16×21-1/8×4-3/4	49-13/16×21-1/8×4-3/4
	Net weight/Gross weight	lbs	9.3/13.2	9.3/13.2	9.3/13.2
Loading quantity	40' GP	set	138	138	
	40' HQ	set	138	138	

## Wall-mounted Type

Model		-	GMV-ND06G/B4B-T(U)	GMV-ND07G/B4B-T(U)	GMV-ND09G/B4B-T(U)	GMV-ND12G/B4B-T(U)
Capacity	Cooling	Btu/h	6000	7500	9500	12000
	Heating	Btu/h	6000	8500	10,500	13,500
Power supply	V/Ph/Hz		208/230/1/60			
Power Input	W		20	20	20	25
Airflow volume ( H/M/L )	m³/h		500/440/300	500/440/300	500/440/300	630/460/320
	CFM		294/259/177	294/259/177	294/259/177	371/271/188
MCA	A		1	1	1	1
MOP	A		15	15	15	15
Sound pressure level(H/M/L)	dB(A)		35/33/30	35/33/30	35/33/30	38/35/31
Connecting pipe diameter	Liquid	In.	Φ1/4	Φ1/4	Φ1/4	Φ1/4
	Gas	In.	Φ3/8	Φ3/8	Φ3/8	Φ1/2
Drain pipe	External dia.	In.	Φ13/16	Φ13/16	Φ13/16	Φ13/16
	Thickness	In.	1/16	1/16	1/16	1/16
Dimension (W×D×H)	Outline	In.	33 1/4×11 3/8×8 1/4			
	Package	In.	38 7/16×11 1/16×14 15/16			
Net weight/Gross weight	lbs		23.5/27.5			
Loading quantity	40' GP	set	576			
	40' HQ	set	576			

Model		-	GMV-ND14G/B4B-T(U)	GMV-ND18G/B4B-T(U)	GMV-ND24G/B4B-T(U)	GMV-ND30G/B4B-T(U)	GMV-ND36G/B4B-T(U)
Capacity	Cooling	Btu/h	15,000	18,000	24,000	30,000	32,500
	Heating	Btu/h	17,000	20,000	25,500	34,000	36,000
Power supply	V/Ph/Hz		208/230/1/60				
Power Input	W		35	50	65	80	100
Airflow volume ( H/M/L )	m³/h		850/580/500	1100/850/650	1200/850/650	1550/1050/800	1650/1100/900
	CFM		500/341/294	647/500/383	706/500/383	912/618/471	971/647/530
MCA	A		1	1	1	1	1
MOP	A		15	15	15	15	15
Sound pressure level(H/M/L)	dB(A)		43/40/37	43/41/37	44/41/37	49/46/40	52/48/40
Connecting pipe diameter	Liquid	In.	Φ1/4	Φ3/8	Φ3/8	Φ3/8	Φ3/8
	Gas	In.	Φ1/2	Φ5/8	Φ5/8	Φ5/8	Φ5/8
Drain pipe	External dia.	In.	Φ13/16	Φ13/16	Φ13/16	Φ13/16	Φ13/16
	Thickness	In.	1/16	1/16	1/16	1/16	1/16
Dimension (W×D×H)	Outline	In.	38 3/16×11 13/16×8 13/16	42 7/16×12 13/16×9 11/16			53 1/8×10 3/16×12 13/16
	Package	In.	43 1/8×15 1/16×12 5/8	47 3/8×16 1/4×13 3/4			58 7/8×16 9/16×14 1/2
Net weight/Gross weight	lbs		27.5/34.5	35.5/42			41/52
Loading quantity	40' GP	set	448	282			228
	40' HQ	set	512	329			266

## Console

Model		-	GMV-ND07C/A-T(U)	GMV-ND09C/A-T(U)	GMV-ND12C/A-T(U)	GMV-ND18C/A-T(U)
Capacity	Cooling	Btu/h	7500	9500	12,000	18,000
	Heating	Btu/h	8500	11,000	13,500	20,000
Power supply	V/Ph/Hz		208/230/1/60			
Power Input	W		38	38	38	38
Airflow volume ( H/M/L )	m³/h		400/320/270	400/320/270	480/400/310	680/600/500
	CFM		235/188/159	235/188/159	282/235/182	400/353/294
Sound pressure level(H/M/L)	dB(A)		38/33/27	38/33/27	40/37/32	46/43/39
Connecting pipe diameter	Liquid	In.	Φ 1/4	Φ 1/4	Φ 1/4	Φ 1/4
	Gas	In.	Φ 3/8	Φ 3/8	Φ 1/2	Φ 1/2
Drain pipe	External dia.	In.	Φ 1-1/9	Φ 1-1/9	Φ 1-1/9	Φ 1-1/9
	Thickness	In.	1/25	1/25	1/25	1/25
Dimension (W×D×H)	Outline	In.	27 9/16×8 1/2×23 5/8	27 9/16×8 1/2×23 5/8	27 9/16×8 1/2×23 5/8	27 9/16×8 1/2×23 5/8
	Package	In.	31×11 1/8×30 5/8	31×11 1/8×30 5/8	31×11 1/8×30 5/8	31×11 1/8×30 5/8
Net weight/Gross weight	lbs		35/42	35/42	35/42	35/42
Loading quantity	40' GP	set	348	348	348	348
	40' HQ	set	348	348	348	348

## Floor Ceiling Type

Model		-	GMV-ND09ZD/A-T(U)	GMV-ND12ZD/A-T(U)	GMV-ND18ZD/A-T(U)	GMV-ND24ZD/A-T(U)
Capacity	Cooling	Btu/h	9500	12,000	18,000	24,000
	Heating	Btu/h	10,500	13,500	20,000	27,000
Power supply	V/Ph/Hz		208/230/1/60			
Power consumption	W		40	40	50	75
Airflow volume(H/M/L)	m³/h		650/585/520	650/585/520	950/865/699	1400/1150/1085
	CFM		380/345/305	380/345/305	560/510/410	825/675/640
MCA	A		1	1	1	1
MOP	A		15	15	15	15
Sound pressure level(H/M/L)	dB(A)		36/34/32	36/34/32	42/38/33	44/42/39
Connecting pipe	Liquid	In.	Φ1/4	Φ1/4	Φ3/8	Φ3/8
	Gas	In.	Φ3/8	Φ1/2	Φ5/8	Φ5/8
Drain pipe	External dia.	In.	Φ11/16	Φ11/16	Φ11/16	Φ11/16
	Thickness	In.	1/16	1/16	1/16	1/16
Dimension (W×D×H)	Outline	In.	48×27-9/16×8-7/8	48×27-9/16×8-7/8	48×27-9/16×8-7/8	56×27-9/16×9-5/8
	Package	In.	52-7/8×32-3/8×12-3/8	52-7/8×32-3/8×12-3/8	52-7/8×32-3/8×12-3/8	60-15/16×32-5/8×13-9/16
Net weight/Gross weight	lbs		88/108	88/108	88/108	110/128
Loading quantity	40' GP	set	145	145	145	90
	40' HQ	set	158	158	158	98

Model		-	GMV-ND30ZD/A-T(U)	GMV-ND36ZD/A-T(U)	GMV-ND42ZD/A-T(U)	GMV-ND48ZD/A-T(U)
Capacity	Cooling	Btu/h	30,000	36,000	42,000	48,000
	Heating	Btu/h	33,000	40,000	47,000	54,000
Power supply	V/Ph/Hz		208/230/1/60			
Power consumption	W		140	160	160	160
Airflow volume(H/M/L)	m³/h		1600/1445/1183	2000/1600/1282	2000/1813/1452	2000/1813/1452
	CFM		940/850/695	1180/904/755	1180/1065/855	1180/1065/855
MCA	A		1	1	1	1
MOP	A		15	15	15	15
Sound pressure level(H/M/L)	dB(A)		50/47/43	51/47/42	52/49/45	52/49/45
Connecting pipe	Liquid	In.	Φ3/8	Φ3/8	Φ3/8	Φ3/8
	Gas	In.	Φ5/8	Φ5/8	Φ5/8	Φ5/8
Drain pipe	External dia.	In.	Φ11/16	Φ11/16	Φ11/16	Φ11/16
	Thickness	In.	1/16	1/16	1/16	1/16
Dimension (W×D×H)	Outline	In.	55-7/8×27-9/16×9-5/8	66-15/16×27-9/16×9-5/8	66-15/16×27-9/16×9-5/8	66-15/16×27-9/16×9-5/8
	Package	In.	60-15/16×32-5/8×13-9/16	71-15/16×32-5/8×13-9/16	71-15/16×32-5/8×13-9/16	71-15/16×32-5/8×13-9/16
Net weight/Gross weight	lbs		110/128	132/150	132/150	132/150
Loading quantity	40' GP	set	90	84	84	84
	40' HQ	set	98	98	98	98



## Air Handler

Model		-	GMV-ND09A/A-T(U)	GMV-ND12A/A-T(U)	GMV-ND18A/A-T(U)	GMV-ND24A/A-T(U)
Capacity	Cooling	Btu/h	9500	12,000	18,000	24,000
	Heating	Btu/h	10,500	13,500	20,000	27,000
Power supply	V/Ph/Hz		208/230~1~60			
Power Input	W		55	55	130	130
Airflow volume ( H/M/L )	m³/h		950/650/550	950/650/550	1400/1200/950	1400/1200/950
	CFM		559/383/324	559/383/324	824/706/559	824/706/559
MCA	A		1.4	1.4	1.4	1.4
MOP	A		15	15	15	15
ESP	In.W.G		0.1/0~0.3	0.1/0~0.3	0.1/0~0.3	0.1/0~0.3
Sound pressure level(H/M/L)	dB(A)		36/34/32	36/34/32	45/43/41	45/43/41
Connecting pipe diameter	Liquid	In.	Φ1/4	Φ1/4	Φ3/8	Φ3/8
	Gas	In.	Φ3/8	Φ1/2	Φ5/8	Φ5/8
Drain pipe	Thread specification		G1	G1	G1	G1
Dimension (W×D×H)	Outline	In.	18-1/8×21-1/4×43-1/2	18-1/8×21-1/4×43-1/2	18-1/8×21-1/4×43-1/2	18-1/2×21-1/4×43-1/2
	Package	In.	20-3/8×24-3/8×46-1/8	20-3/8×24-3/8×46-1/8	20-3/8×24-3/8×46-1/8	20-3/8×24-3/8×46-1/8
Net weight/Gross weight	Lbs		119/128	119/128	124/135	124/135
Loading quantity	40'GP	set	164	164	164	164
	40'HQ	set	172	172	172	172

Model		-	GMV-ND30A/A-T(U)	GMV-ND36A/A-T(U)	GMV-ND42A/A-T(U)	GMV-ND48A/A-T(U)	GMV-ND54A/A-T(U)
Capacity	Cooling	Btu/h	30,000	36,000	42,000	48,000	54,000
	Heating	Btu/h	34,000	40,000	47,000	54,000	60,000
Power supply	V/Ph/Hz		208/230~1~60				
Power Input	W		190	300	380	440	450
Airflow volume ( H/M/L )	m³/h		1500/1200/950	2300/2000/1700	2450/2150/1900	2750/2550/2300	2850/2650/2300
	CFM		882/706/559	1353/1176/1000	1441/1265/1118	1618/1500/1353	1676/1559/1353
MCA	A		1.8	3.3	3.4	4.3	4.4
MOP	A		15	15	15	15	15
ESP	In.W.G		0.15/0~0.3	0.15/0~0.4	0.15/0~0.4	0.2/0~0.5	0.2/0~0.5
Sound pressure level(H/M/L)	dB(A)		46/44/42	49/47/45	50/48/46	51/49/47	52/50/48
Connecting pipe diameter	Liquid	In.	Φ3/8	Φ3/8	Φ3/8	Φ3/8	Φ3/8
	Gas	In.	Φ5/8	Φ5/8	Φ5/8	Φ5/8	Φ5/8
Drain pipe	Thread specification		G1	G1	G1	G1	G1
Dimension (W×D×H)	Outline	In.	18-1/2×21-1/4×43-1/2	21-1/4×21-1/4×48-1/4	21-1/4×21-1/4×48-1/4	24-7/8×21-1/4×48-1/4	24-7/8×21-1/4×48-1/4
	Package	In.	20-3/8×24-3/8×46-1/8	23-1/2×24-3/8×50-3/4	23-1/2×24-3/8×50-3/4	27×24-1/2×51	27×24-1/2×51
Net weight/Gross weight	lbs		124/135	148/159	148/159	179/192	179/192
Loading quantity	40'GP	set	164	85	85	85	85
	40'HQ	set	172	114	114	114	114

## Fresh Air Processing Unit

Model		-	GMV-NDX42P/A-T(U)	GMV-NDX48P/A-T(U)	GMV-NDX54P/A-T(U)	GMV-NDX72P/A-T(U)	GMV-NDX96P/A-T(U)
Capacity	Cooling	Btu/h	42,000	48,000	54,000	72,000	96,000
	Heating	Btu/h	29,000	34,000	45,000	55,000	68,000
Power supply	V/Ph/Hz		208/230/1/60				
Power consumption	W		350	350	760	760	860
Airflow volume(H/M/L)	m³/h		1200/1000~2000	1200/1000~2000	2000/1500~3000	2000/1500~3000	2500/2000~3500
	CFM		706/589~1177	706/589~1177	1177/883~1766	1177/883~1766	1471/1177~2060
MCA	A		1.7	1.7	6.3	6.3	6.3
MOP	A		15	15	15	15	15
ESP	In.W.G		0.6/0.2~0.8	0.6/0.2~0.8	0.8/0.2~1.2	0.8/0.2~1.2	0.8/0.2~1.2
Sound pressure level(H/M/L)	dB(A)		40~50	40~50	45~54	45~54	47~54
Connecting pipe	Liquid	In.	Φ3/8	Φ3/8	Φ3/8	Φ3/8	Φ3/8
	Gas	In.	Φ5/8	Φ5/8	Φ3/4	Φ3/4	Φ7/8
Drain pipe	External dia.	In.	Φ1	Φ1	Φ1	Φ1	Φ1
	Thickness	In.	3/32	3/32	1/16	1/16	1/16
Dimension (W×D×H)	Outline	In.	55-1/8×27-9/16×11-13/16	55-1/8×27-9/16×11-13/16	58-3/8×31-1/8×15-3/16	58-3/8×31-1/8×15-3/16	58-3/8×31-1/8×15-3/16
	Package	In.	63×32×14-3/8	63×32×14-3/8	62-1/8×34-3/4×18-5/8	62-1/8×34-3/4×18-5/8	62-1/8×34-3/4×18-5/8
Net weight/Gross weight	lbs		119/134	119/134	181/229	181/229	181/229
Loading quantity	40' GP	set	84	84	52	52	52
	40' HQ	set	98	98	65	65	65

## AHU KIT

Model		-	GMV-N12U/C-T(U)*	GMV-N24U/C-T(U)*	GMV-N48U/C-T(U)*	GMV-N96U/C-T(U)*	GMV-N192U/C-T(U)*											
Defaulted capacity of ex-factory	Capacity		12	24	48	96	192											
	Cooling	Btu/h	12,000	24,000	48,000	96,000	192,000											
	Heating	Btu/h	13,500	27,000	54,000	108,000	216,000											
Adjustable capacity	Capacity		9	12	15	18	24	30	36	48	72	96	120	144	168	192	288	
	Cooling	Btu/h	9500	12,000	15,000	18,000	24,000	30,000	36,000	48,000	72,000	96,000	120,000	144,000	168,000	192,000	288,000	
	Heating	Btu/h	10,500	13,500	17,000	20,000	27,000	34,000	40,000	54,000	81,000	108,000	135,000	162,000	189,000	216,000	324,000	
Power input	W		8.0	8.0	8.0	8.0	8.0											
Power Supply	V/Ph/Hz		208/230/1/60		208/230/1/60		208/230/1/60		208/230/1/60		208/230/1/60		208/230/1/60					
Size of connection pipe	AHU-KIT		In.	Φ1/4	Φ1/4	Φ3/8	Φ3/8	Φ3/8	Φ3/8	Φ3/8	Φ3/8	Φ3/8	Φ3/8	Φ3/8	Φ5/8	Φ5/8	Φ5/8	
	Air handling unit	Liquid pipe	In.	Φ1/4	Φ1/4	Φ1/4	Φ3/8	Φ3/8	Φ3/8	Φ3/8	Φ3/8	Φ3/8	Φ3/8	Φ1/2	Φ1/2	Φ5/8	Φ5/8	Φ3/4
		Gas pipe	In.	Φ3/8	Φ1/2	Φ1/2	Φ5/8	Φ5/8	Φ5/8	Φ5/8	Φ5/8	Φ3/4	Φ7/8	Φ1-1/8	Φ1-1/8	Φ1-1/8	Φ1-1/8	Φ1-3/8
Connection method		Brazeing Connection		Brazeing Connection		Brazeing Connection		Brazeing Connection		Brazeing Connection		Brazeing Connection						
Outline dimension (W×D×H)	EXV box	In.	8×12-7/8×3-3/8	8×12-7/8×3-3/8	8×12-7/8×3-3/8	8×12-7/8×3-3/8	9-5/8×19-5/8×4-3/4											
	Control box	In.	13-1/8×11-1/8×4-3/8	13-1/8×11-1/8×4-3/8	13-1/8×11-1/8×4-3/8	13-1/8×11-1/8×4-3/8	13-1/8×11-1/8×4-3/8											
Package dimension	In.		21-1/4×18-1/8×9-5/8	21-1/4×18-1/8×9-5/8	21-1/4×18-1/8×9-5/8	21-1/4×18-1/8×9-5/8	29-7/8×25-3/8×7											
Net weight	lbs		22	23	23	23	29											
Gross weight	lbs		29	30	30	30	39											
Loading	40'GP	set	990	990	990	990	702											
	40'HP	set	1100	1100	1100	1100	756											

\*Note: This product is under development. Gree reserves the right to modify the specifications without prior notice.

# Control System



# Control System



## VRF Selector Ultimate

A model selection system is a necessary tool for the sales of the VRF system in the overseas market. In order to meet the demand of the overseas market for the model selection system, improve the competitive strength of Gree products in the overseas market. Gree provides clients with intelligent, fast and multivariate model selection systems.

### Intelligent Model Selection

- 1) The system will take multiple aspects into consideration to provide clients with the optimal plan by combining performance, noise, comfort, reliability, cost, etc.
- 2) It can calculate according to user demand, ambient temperature, using location, static pressure, etc. to recommend the suitable IDU, ODU and pipe arrangement. It will check by combining the collocation rate, pipe arrangement, etc. of the whole system, and automatically adjust the unit model to get the optimal model selection plan.
- 3) Using habit and using standard differs in different regions. The intelligent model selection system will conduct a special process according to metric/inch system, unit parameters, different language systems in different regions.
- 4) It will conduct automatic checking for the whole system. If anyone of the conditions cannot satisfy the user demand, the software will automatically calculate to find a suitable unit and pipe arrangement.



### Fast Model Selection

The software can provide users with audio-visual model building experience via a visible modeling method. Through the intelligent fast connection, multiple parts of VRF can be correctly and fast linked, which can greatly improve the modeling efficiency of user.





## Multivariate Model Selection

The model selection system will launch multiple model selection terminal applications around the core of model selection parameter data according to different user groups. The model selection data can achieve data resource sharing on the basis of a cloud server, which can provide different terminal users with standard and professional model selection service.

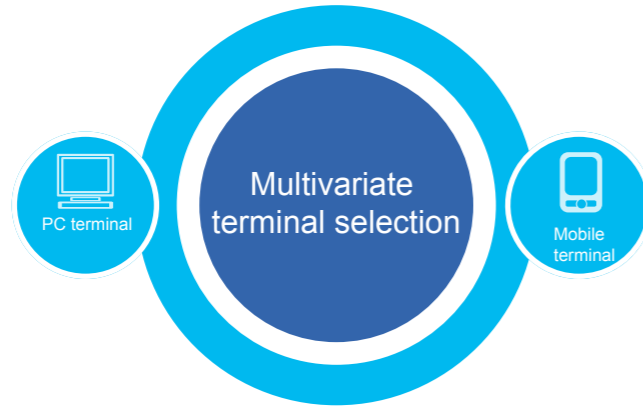

### Mobile APP model selection

The mobile APP model selection user terminal, which is developed by using cross-platform technology and can be embedded in other APP to use. It supports multiple units for selection and two basic languages: Chinese and English, making the software more user-friendly.

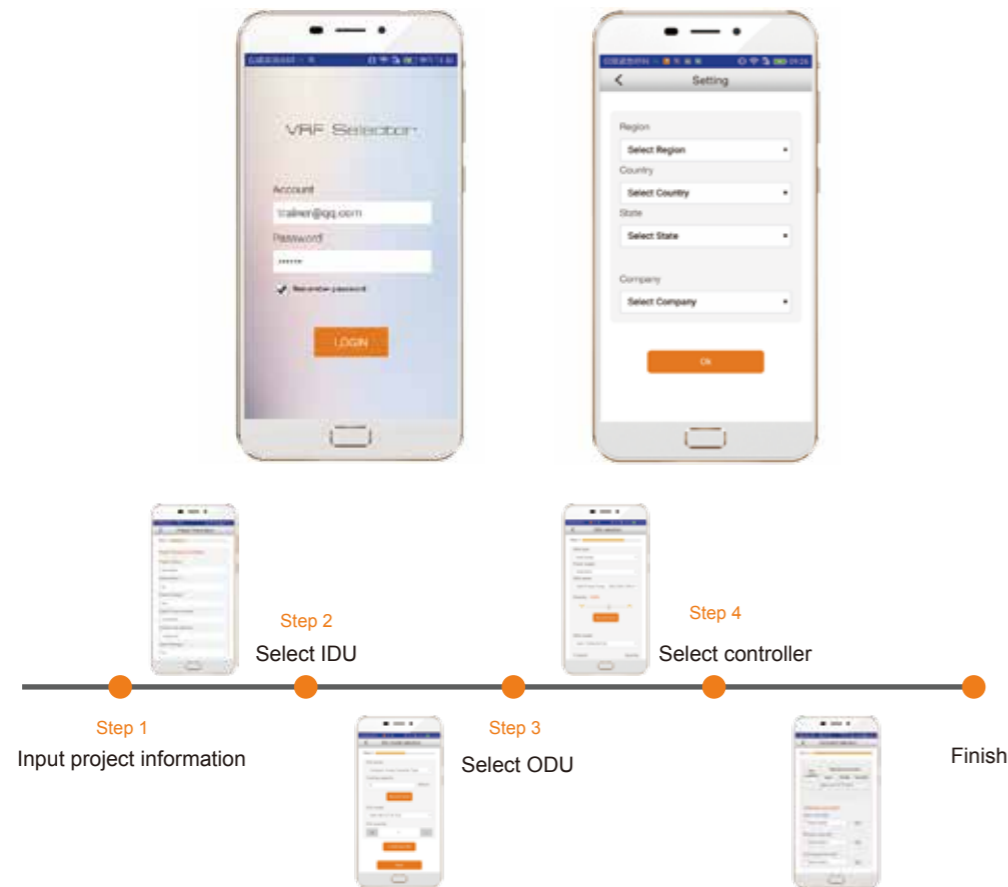

## Intelligent Debugging Software

GMV5 offers intelligent debugging software to the end-users for faster construction needs.

### Monitoring functions

- Fully control the operation status of each device of the system;
- Hover the mouse over the parameter to display its remarks.
- The online devices will be displayed in a tree structure;
- Display the information of the air conditioner in divided regions;
- Each display region can be moved or concealed;
- Display updated status of units in real-time;

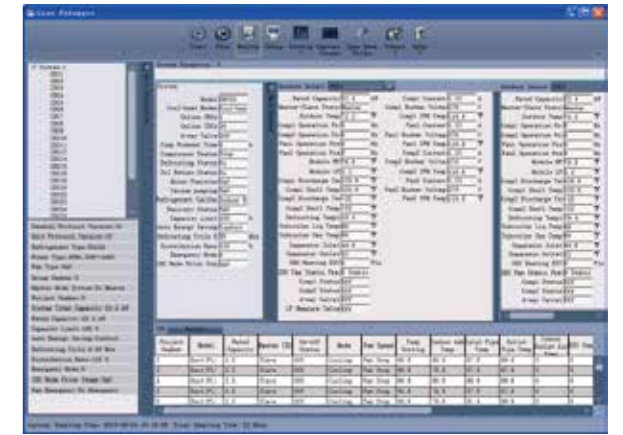

### Control functions

- Control the operation of the unit as you like;
- Comprehensive control of outdoor unit, indoor unit, water tank, hydro box, etc.;
- Real-time display of current status or status after being controlled;
- Both single control and group control are available.



### Project debugging functions

- One-click and automatic project debugging;
- Project debugging is arranged step by step from left to right;
- Manual intervention and skipping of some debugging phases are available.
- Green icons will be displayed for the items finishing debugging; red icons will be displayed for the items having debugged exception; light yellow icons display debugging information;

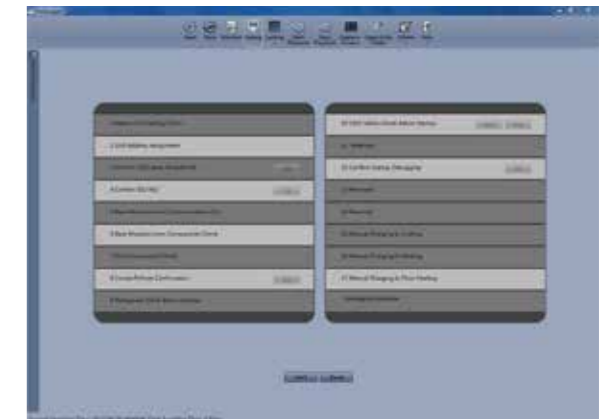

### Auto data-saving function

Data will be saved automatically. The database saving path can be changed or data documents can be generated repeatedly.



Step 1: Change Database Saving Path

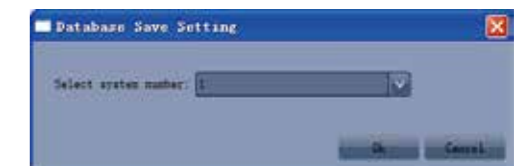

Step 2: Database Save Setting

## USB data converter

Users can use USB data converter to freely convert CAN/HBS/RS485 data into USB data, achieving data interchange between computer and air conditioner.

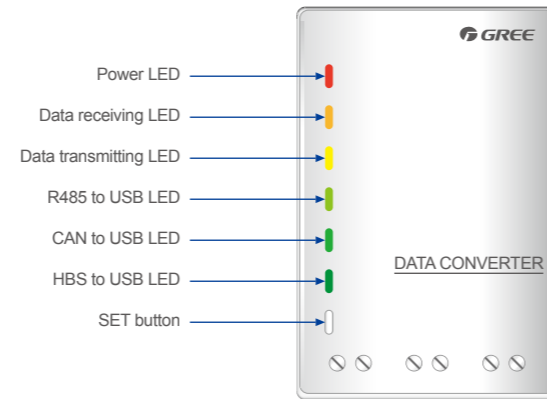

## Auto direction of connection way

The wiring diagram will direct connection way automatically, so that the user can get the connection way quickly.

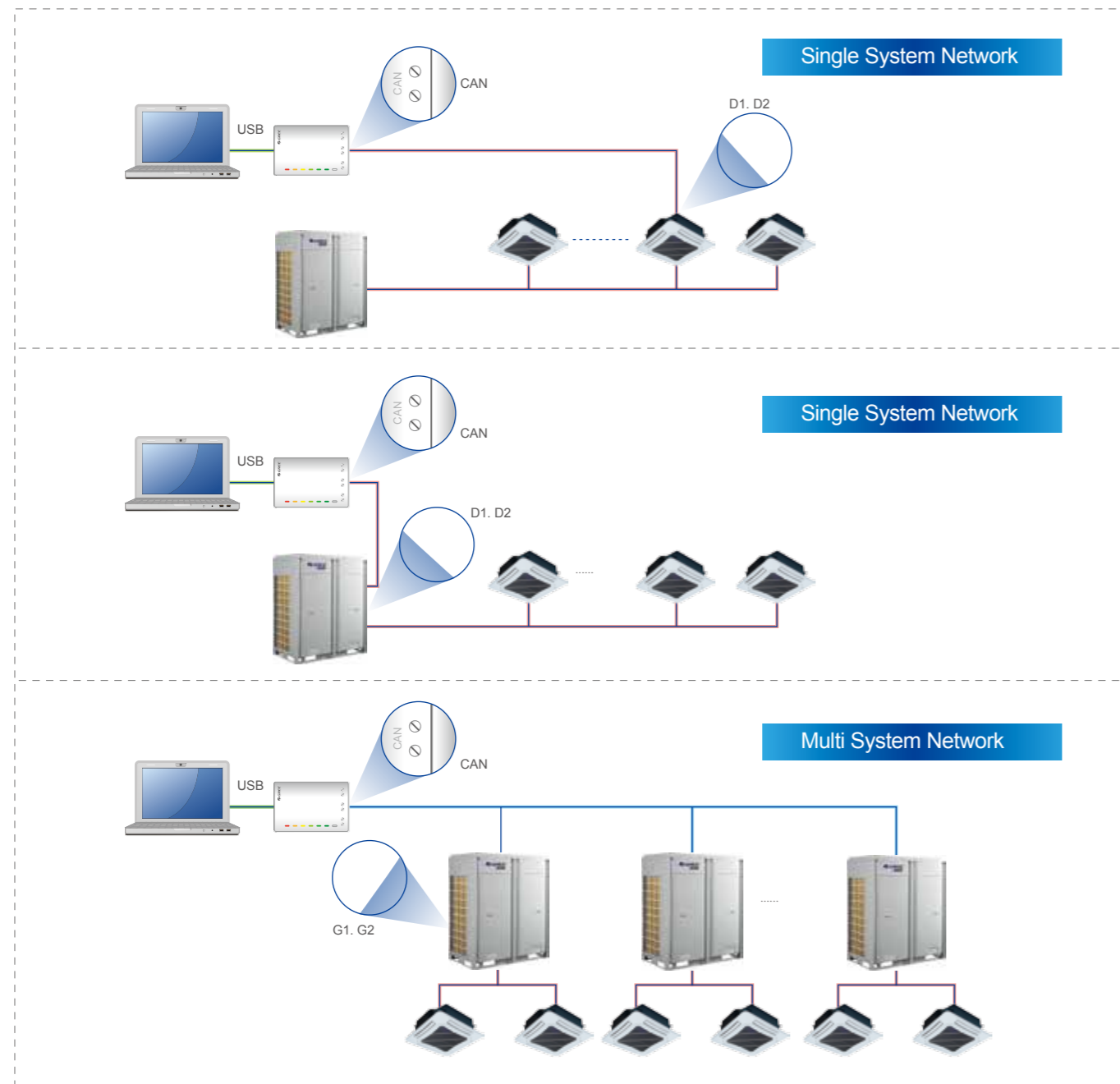

# Intelligent Remote Eudemon

With the design philosophy to be intelligent, smart, inclusive and compatible, Gree developed the Intelligent Remote Eudemon System for VRF units, providing users with a distributed remote monitoring system for VRF units. By adopting the latest technologies and combining the features of engineering construction and debugging, this system is more compatible while less difficult to be installed and debugged. It can be widely used in industrial parks, shopping centers, office buildings, apartment blocks, villa clusters or other commercial or residential occasions, satisfying the demands of large-scale or cross-city networking.

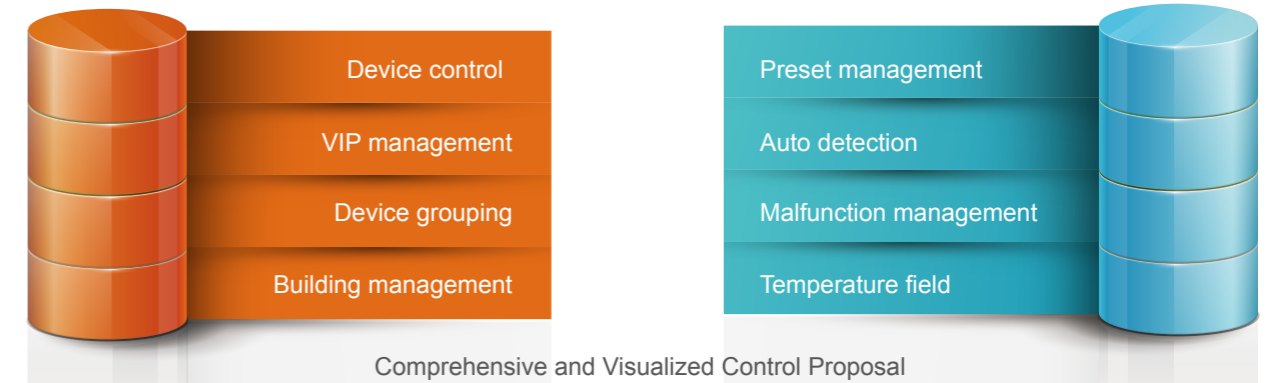

## 6 Key Functions

- Device monitoring**  
 It can monitor and control the parameters of every air conditioning device within the system, for example, on/off, running mode, set temperature, ambient temperature, etc., presenting the communication and malfunction data of air conditioners in a visual way.
- Remote control**  
 An administrator can log in the control system through web browser on any kinds of terminals (from a long-distance. Based on the user's property management payment or energy-saving needs, you can control the on/off, temperature, running mode or other controllable parameters of any indoor unit from a long distance.
- Malfunction alarm**  
 When there's malfunction for the air conditioner, the system will report in real-time and display malfunction details to users or after-sales service staff for the convenience of locating malfunction and timely maintenance.
- Property management**  
 Visual management: It provides three viewing and control modes in regard to devices, engineering, and grouping. You can set "alias" for indoor units, change the details according to structural alteration and view clearly the condition of devices in each area, which is convenient for management.
- Schedule management**  
 It provides customized schedule preset mode and auto-switch between "workday mode" and "holiday mode", satisfying different scheduling demands of commercial buildings, workplaces, family units, etc.
- Temperature field**  
 This module provides a temperature gradient setting function for users. The user can customize the arrangement order of the room in the temperature field. The system can automatically generate the appropriate temperature for each room, so as to reduce the impact of sudden temperature change between inside and outside.

## 4 Key Features

- Distributed design for balancing the load**  
 With distributed structure, the gateway has independent logical memory capability and can perform data processing for the first time, reducing the pressure on a server (Intelligent Remote Eudemon). Once customized preset is made, each gateway can work independently, no need to keep connecting to the software.
- Adopt WEB technology based on HTML5, control the system anywhere**  
 The software adopts B/S structure. With system's core functions installed on the server-side, the front end adopts HTML5 technology and the web browser is the client-side. You can control the system on different platforms and terminals.
- Design according to the project, increase interactive experience for convenient debugging and use**  
 It adopts visual interactive design, supports one-button import of details, engineering information, and so on, making the modification and debugging more convenient, and the operation more visualized and reliable. On the basis of Ethernet, the building's local network can be utilized directly without the need to build an air conditioning network, saving materials and construction time.
- Fast, reliable and in real-time**  
 Instead of using RS485 communication method, it adopts "CAN+Ethernet", which features high efficiency and large data volume. You can view units' conditions in real-time and control over 4,000 air conditioners in seconds.

## Intelligent Remote Controller

With the design philosophy being smart, inclusive and compatible, Gree developed the Intelligent Remote Eudemon System for VRF units. By adopting State of the art controls & smart technology this system offers superior compatibility, interoperable with central building automation, and installation flexibility. It can be widely used in industrial parks, shopping centers, office buildings, apartments, as well as, many other commercial or residential applications. The web- based system facilitates control of multiple facilities across a wide geographic area.

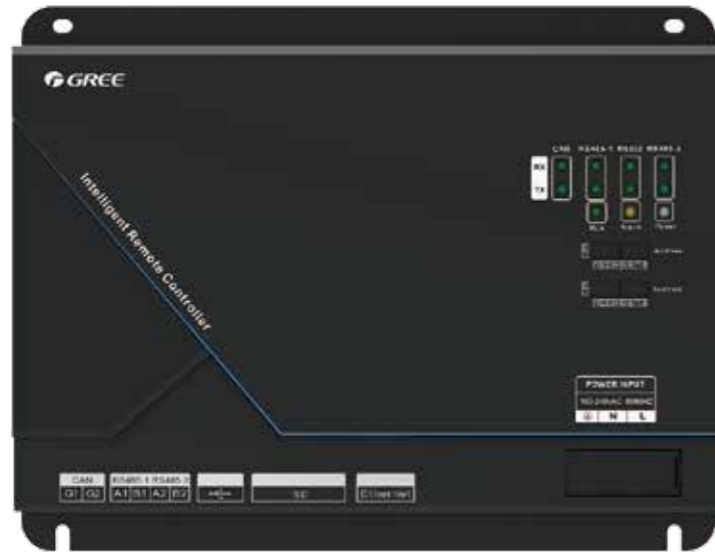

Dimension  
266×208×59mm  
10-4/8×8-2/8×2-3/8 inch

### Functional Features

- Big capacity**  
One controller can connect with 255 indoor units (16 systems).
- Visualized and convenient configuration**  
The controller adopts integrated WEB technology, providing a visualized configuration page to improve configuration efficiency.
- CE and ETL certification**  
The controller complies with CE and ETL certification, which is safe and reliable.
- High efficiency**  
800MHz processor is adopted to handle interaction data and respond to control commands precisely in the second level.

## Distributed Structure

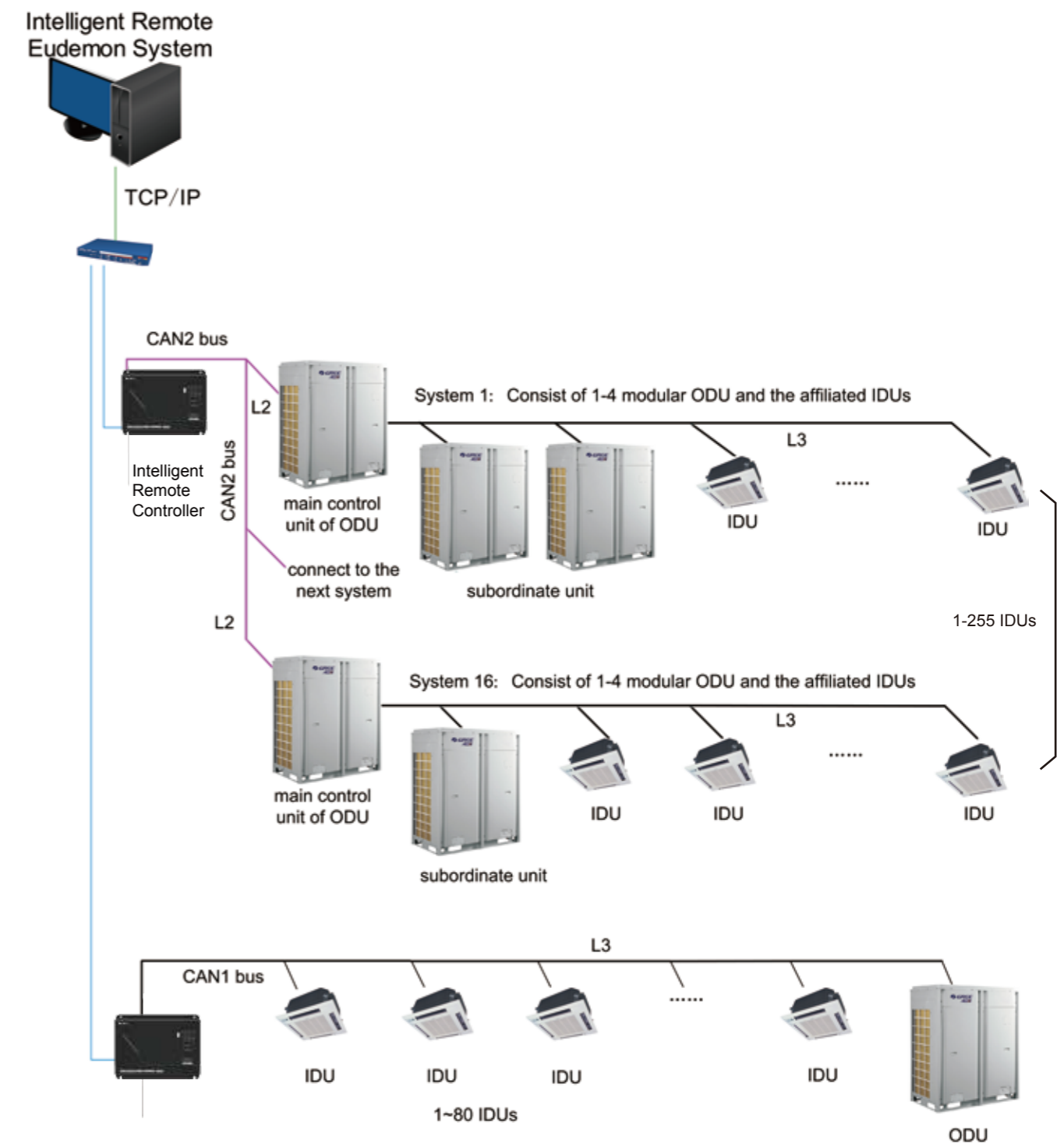

Note:

- 16 systems or 255 indoor units can be connected to one Intelligent Remote Controller.
- 32 Intelligent Remote Controllers can be connected to one set of Intelligent Remote Eudemon (customized order is available).



# Building Protocol Gateway

An air conditioner is a kind of indispensable equipment in the building, which has a higher and higher requirement of automation and intelligence. In order to meet the demand of users to solve the problems of air conditioner monitoring and automatic control, Gree has developed multiple building protocol gateways for connecting to different BMS or BAS systems.

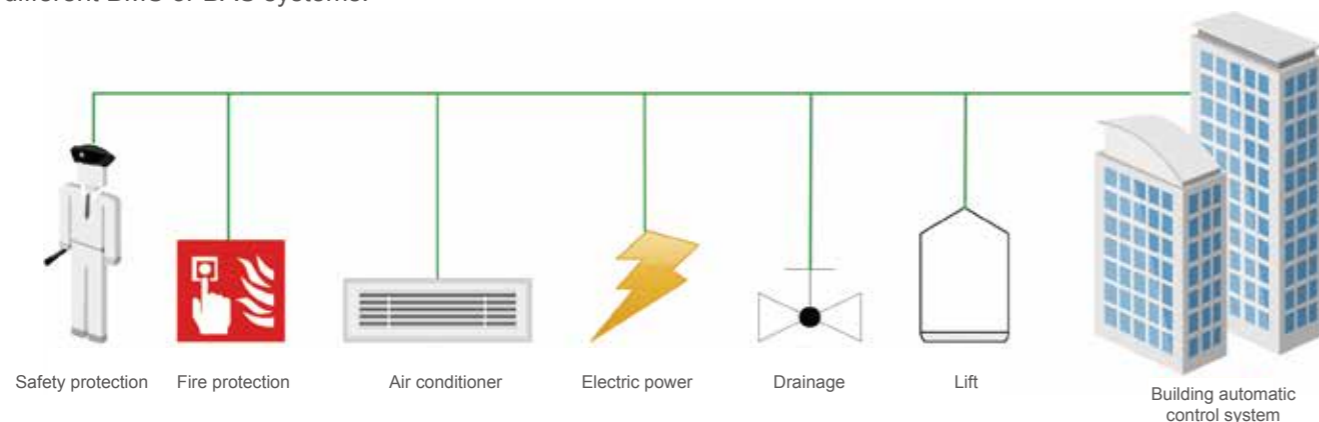

## BACnet Gateway

### Functional Features

- **Large network capacity**  
One BACnet Gateway can support 16 systems or 255 sets of IDU at most;
- **Group control function**  
BACnet Gateway supports group control ON/OFF of units;
- **Long distance monitor**  
BACnet Gateway supports the remote control of ON/OFF of the unit, temperature setting, mode setting, fan speed setting, and shielding function, etc., and can achieve real-time monitor of operating status (ambient temperature, ON/OFF status of the unit, etc.), error status (communication error, operational error, different sensor error of the unit, etc.);
- **Easy control**  
BACnet Gateway supports collocating gateway IP and related data for embedded webpage, thus a user can self-define the gateway IP according to the actual situation;
- **I/O expansion**  
BACnet Gateway supports 5 digital input (DI) and output (DO) interfaces, in which DI1 is defined as fire alarm signal input interface, and other I/O interfaces can be self-defined by the user;

### Strong Points

- **Provide standard BACnet/IP protocol interface, open the table of protocol point**  
BACnet Gateway provides standard BACnet/IP protocol interface, open the table of BACnet protocol point (unit parameter example No.), for the integration of the building of user;
- **Adopt HTML5 technology, adapt to a different environment**  
BACnet Gateway embedded webpage is developed by adopting HTML5 technology, which can set the gateway IP and related information in the Windows system, Linux system, or Mac OS system.
- **With ETL and CE certification**  
BACnet Gateway has been rewarded with the North America ETL and EU CE safety certification;



Dimension  
266×208×59mm  
10-4/8×8-2/8×2-3/8 inch

## Modbus Gateway Pro

### Functional Features

- **Large network capacity**  
One Modbus Gateway Pro can support 16 systems or 255 sets of IDU at most;
- **Group control function**  
Modbus Gateway Pro supports group control of ON/OFF of the unit, temperature setting, mode setting, fan speed setting, and locking functions;
- **The long distance monitor**  
Modbus Gateway Pro supports the remote control of ON/OFF of the unit, temperature setting, mode setting, fan speed setting, and shielding function, etc., and can achieve real-time monitor of operating status (ambient temperature, ON/OFF status of the unit, etc.), error status (communication error, operational error, different sensor error of unit, etc.);
- **I/O expansion**  
Modbus Gateway Pro supports 5 digital input (DI) and output (DO) interfaces, in which DI1 is defined as fire alarm signal input interface, other I/O interfaces can be self-defined by the user;



Dimension  
266×208×59mm  
10-4/8×8-2/8×2-3/8 inch

### Strong Points

- **1 gateway can monitor 255 indoor units**
- **Linkable with other networks**  
5 ways of digital input and output enable flexible connection to other networks.
- **Fire alarm interface for auto stop**  
When a fire alarm goes off, units can be automatically turned off through the fire alarm interface, which will lower the risk of damage for the units.
- **With ETL and CE certification**  
Modbus Gateway(Pro) has acquired the North America ETL and EU CE safety certification.

# Building Protocol Gateway

## Modbus Gateway(Mini)



Dimension  
113.18x54.58x20.05mm  
4-4/8x2-1/8x6/8 inch

### Functional Features

- **Network capacity**

One Modbus Gateway (Mini) can support 16 systems or 128 sets of IDU at most;

- **Group control function**

Modbus Gateway (Mini) supports group control of ON/OFF of the unit, temperature setting, mode setting, fan speed setting, and locking functions.

- **Long-distance monitor**

Modbus Gateway (Mini) supports the remote control of ON/OFF of the unit, temperature setting, mode setting, fan speed setting, and shielding function, etc., and can achieve real-time monitor of operating status (ambient temperature, ON/OFF status of the unit, etc.), and error status (communication error, operational error, different sensor error of the unit, etc.);

### Strong Points

- **Compact size, easy installation**

The dimension of Modbus Gateway (Mini) is 113.18x54.58x20.05mm, which can be placed in anywhere satisfies the using conditions, which can be fixed with only two screws;

- **Provide standard Modbus RTU protocol interface, open the table of protocol point**

Modbus Gateway (Mini) provides standard Modbus RTU protocol interface, open the table of Modbus protocol point (unit parameter example No.), for the integration of the building of the user;

- **With ETL and CE certification**

Modbus Gateway(Mini) has acquired the North America ETL and EU CE safety certification;

## S2S\* KNX\* Gateway



Dimension  
91.4x72.3x61.9mm  
3-5/8x2-7/8x2-3/8 inch

### Functional Features

- **Scene modes supported**

4 scene modes can be preset and user setting is supported.

- **Standard KNX device with convenient configuration**

It can be directly connected to the bus of KNX/EIB\* system and can be used immediately through the ETS5 configuration.

- **Long-distance monitoring**

The status and error information can be monitored through the KNX bus.

Note: \*S2S:single to single \*KNX:konnex \*EIB:European Installation Bus

### Strong Points

- **CE, ETL and KNX certificate**

Comply with CE and ETL certification.

- **No need for additional power supply**

Power is supplied by the bus with carrier wave communication.

- **Convenient installation**

The installation way of standard 35mm guideway is adopted.

# Intelligent Billing Eudemon

Gree Intelligent Billing System is a solution to power consumption calculation and billing specialized for VRF units. This system adopts Gree's unique calculation method that makes the billing more reasonable. As for design, it's tailored to the features of engineering construction, making the installation less difficult. It can be widely applied in shopping centers, apartment blocks, villa clusters or other commercial or residential occasions in different sizes and for different purposes.

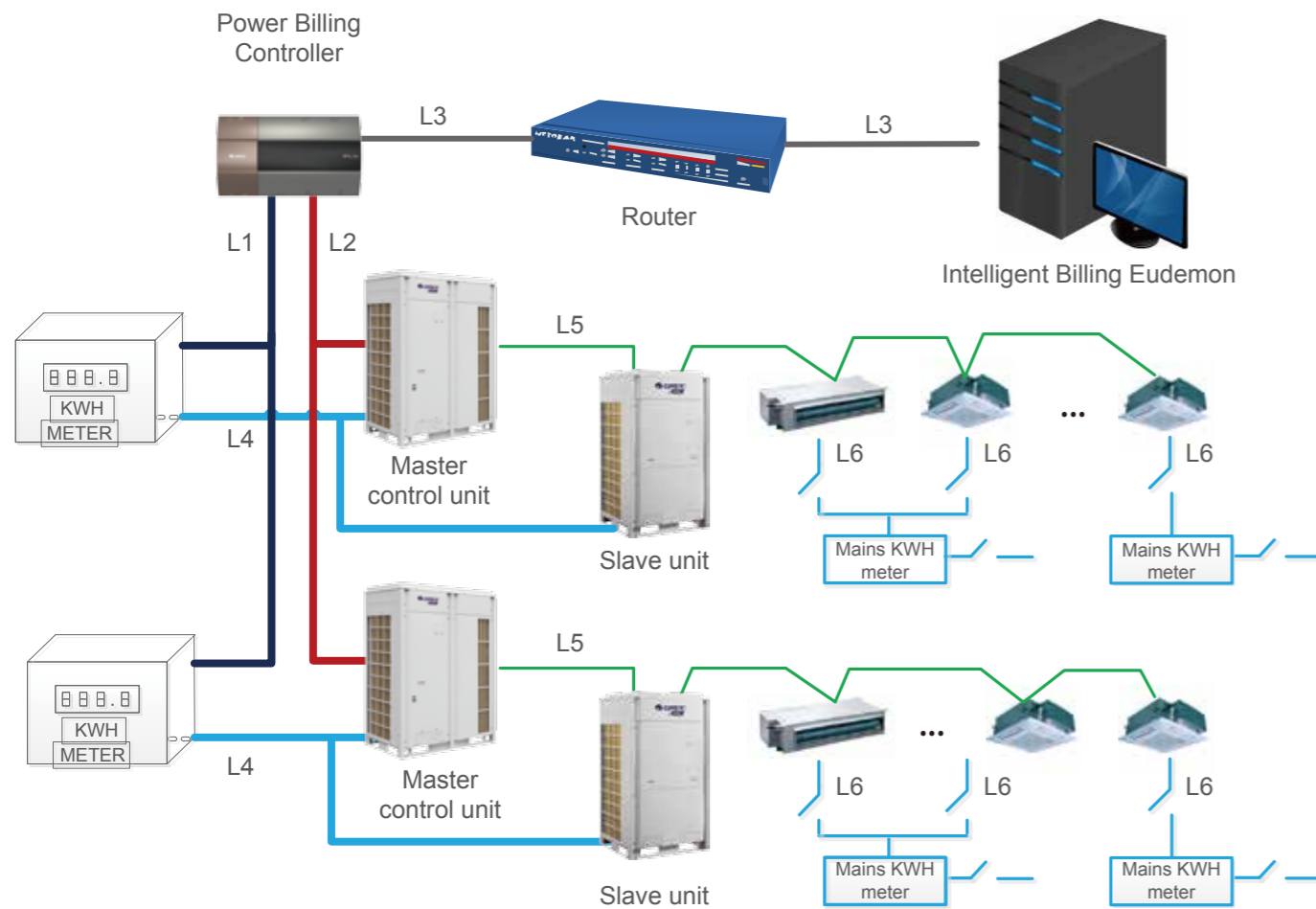

L1: RS485 bus for communication between gateway and KWH meter;  
 L2: CAN2 bus for communication between gateway and unit;  
 L3: Cable;  
 L4: ODU power supply cord;  
 L5: CAN1 bus for communication between IDU and ODU;  
 L6: IDU power supply cord;

Note:

- (1) 15 systems or 255 indoor units can be connected to one Power Billing Controller ;
- (2) 16 Power Billing Controllers can be connected to one set of Intelligent Billing Eudemon;
- (3) One multi VRF system should be configured with one KWH meter.

## 5 Key Functions

### ● Billing management

Properly distribute the electricity automatically according to ON/OFF time, mode, set temperature, indoor ambient temperature, outdoor ambient temperature etc.; provide a detailed bill, operational details, etc.

### ● Arrearage shutdown

When the air conditioner is not available due to overdue bill or other reasons, the shielding function can limit the operation of some of IDU or deactivate some of the functions such as ON/OFF of the unit, operating mode, fan speed, etc.

### ● Long-distance control

The administrator can log in the system via the browser of any terminals, and conduct long-distance control for ON/OFF of IDU, temperature, mode and related controllable parameters according to billing or using situation. Meanwhile, it supports the management of the logging of multiple users.

### ● Error alarm

When there's malfunction for the air conditioner, the system will report in real-time, and display the detailed information of error, and at the same time record to the system database as one of the billing basis.

### ● Property management

Achieve visible management, you may name the project, floors, tenants, and even set "alias" for indoor units. Details can be imported by one button, convenient for building management.

## 4 Highlights

### ● Distributed design for balancing the load and reducing the risk

With distributed structure, the logical operation for billing is built inside the gateway. The software provides centralized management. Each device runs independently, so any failure of a certain device will not affect the stability of the entire system.

### ● Adopt WEB technology based on HTML5, control the system anywhere

The software adopts B/S structure. With the system's core functions installed on the server-side, the front end adopts HTML5 technology and the web browser is the client-side. You can control the system on different platforms and terminals.

### ● Design according to the project, increase interactive experience for convenient debugging and use

It adopts visual interactive design, supports one-button import of details, engineering information, and so on, making the modification and debugging more convenient, and the operation more visualized and reliable.

### ● Compatible to different electric meters

No.	Manufacturer	Electric Meter Model	Country of Origin	Satisfactory Regions (reference)
1	ENTES	EPR-04S-96	Turkey	Turkey, Middle East
2	WattNode	WNC-3D-240-MB	America	North America, Latin America
3	Siemens	PAC3200	Germany	Russia, Europe, Asia Pacific
4	Schneider	iEM3255	France	Australia, Europe
5	Wasion	DTS343	China	China

Note:

1. The billing eudemon is compatible with the above mentioned electric meters, either one of the electric meters can be adopted after being confirmed by the local dealer; the "Satisfactory Regions" in the list are only for reference.
2. The above electric meter model PAC 3200 should be equipped with an RS485 module.



# Cloud Platform for the Internet of Things

## Overall framework

This platform is made up of 4 parts: the management website of a cloud platform for the Internet of Things, server, LTE-DTU (means Long Term Evolution-Data Transfer Unit) and units.

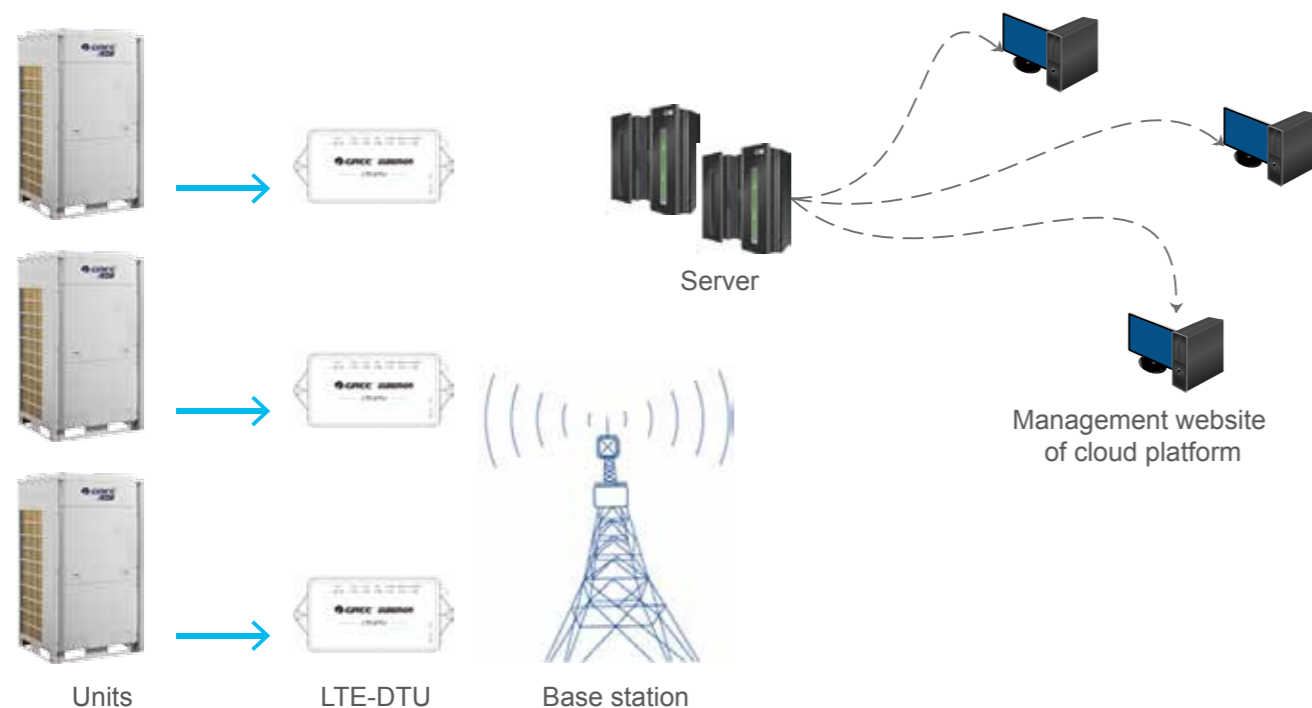

## LTE-DTU

LTE-DTU can realize real-time data collection and uploading, for instance, equipment time recording, debugging report, malfunction report, real-time monitoring, module selection, data de-duplication, parameters logic statistical function, etc. It can deal with data roaming for users. By using LTE-DTU with a cloud platform for the Internet of things, the user can realize real-time data monitoring on units through the management website of the cloud platform.



### Functions

- Malfunction report**  
 When there is a unit with a malfunction, LTE-DTU will be triggered to report data before and after the malfunction occurs;
- Debugging report**  
 When the LTE-DTU detects that the air conditioner is under debugging process, it will report unit data to the server;
- Data statistical function**  
 LTE-DTU can realize real-time calculation for the unit's operation parameters and then feedback the calculation results to the server;

- Real-time monitoring**

User can request real-time monitoring through the management website of a cloud platform. When the LTE-DTU receives the request, it will report the current operation data to the server in real-time and display it on the management website of the cloud platform simultaneously.

- Establishment of project records**

The system can obtain unit information, location information and user information automatically and then establish project records by combining all of the information.



- The query of the faulty project and failure type**

The management website of cloud platform offers queries of current faulty projects so that immediate on-site after-sales service can be provided.

### Key Features

- Data de-duplication**

LTE-DTU adopts a de-duplication algorithm to compress a large quantity of data into a small amount. After the server receives a small amount of data, it will restore them back to a large quantity. This not only reduces the cost of data transmission but also improves the data processing capability of the cloud platform.

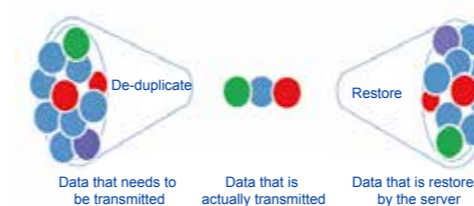

- Project classification**

Unify project properties. Through clustering analysis, a grouping model is set up to realize customized grouping and classification. With the simple, clear and easy-to-operate features of clustering analysis, batch management of projects can be achieved.

- Data safety**

When reporting data to the server, data will go through multiple stages of encryption to ensure the safety and reliability of data.

### Server Deployment

- There are two methods for server deployment**

Use G-Cloud

Users rent or buy a server to deploy and the server shall be managed by users.

### Marketing and Influence

Cloud platform for the Internet of Things can realize integrated management globally.



# G-Cloud

G-Cloud is a new generation WIFI smart controller of Gree commercial units. It adopts a way of operation different from a remote control or wired control. It can display air conditioner running status directly to users, who can conduct point-to-point control over air conditioners through an APP. It is an important part of the Gree smart home. G-Cloud is designed for intelligent home control, such as preset control, long-distance control, scene management, malfunction reminding and family access management.

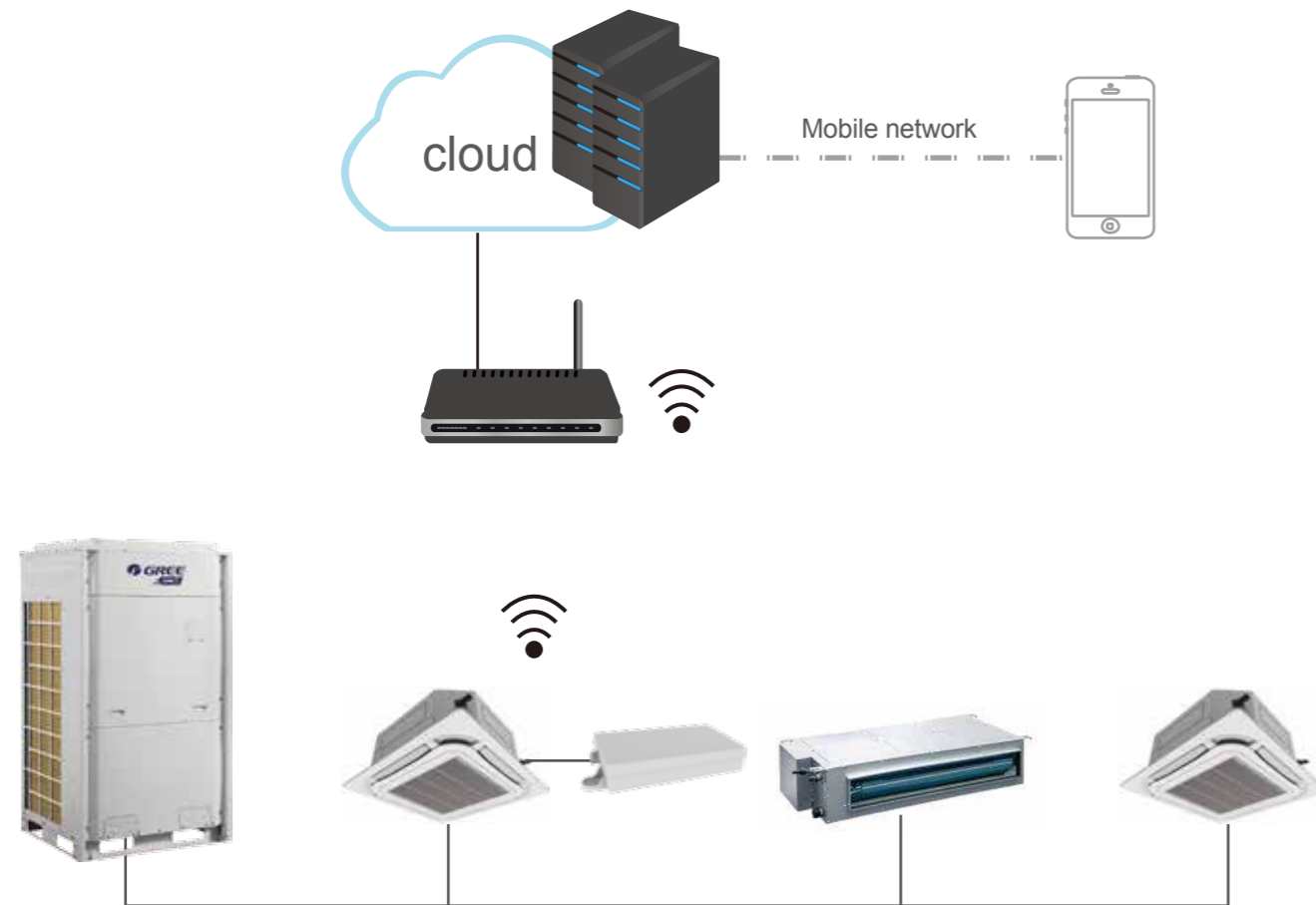

CAN1 network, multi VRF cloud control supports 80 indoor units in a single system, to realize long-distance control

## System Chart

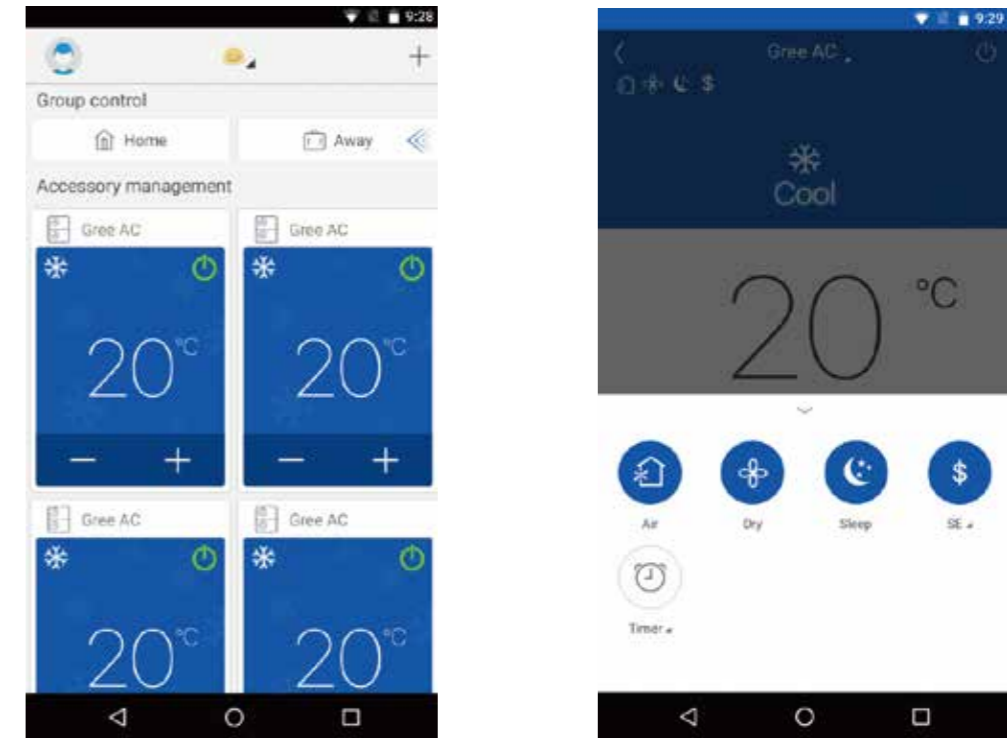

APP operation chart

- Lightweight**  
 Compact and easy to install, no need of external power source; power supplied by equipment, available for use right after connection; a shielded wire of 4 cores is required for connection; easy operation; GREE+APP easy user configuration; quick guidance is provided, with simple and clear display;
- Smart and long-distance control**  
 Users can set the running status of the cooling system based on a set of rules; long-distance control allows you to master your home appliances at any time;
- Capability**  
 Multi VRF cloud control; one set of device is capable of controlling up to 80 sets of indoor units in a single system; applicable to villas, office buildings, shopping malls, hotels, etc;
- Sensitive**  
 Monitor the units and detect errors.

# Wired Controller and Remote Controller

There are two kinds of controllers: a wired controller and a remote controller. The system provides various controls for users, such as cooling, heating, dehumidifying and fan, etc. Users can select it flexibly according to their own using methods.

## Wired Controller XK46



- LCD with a black background and white words; touch buttons;
- A clock can be displayed and set; 24h timer ON and timer OFF;
- 7 fan speeds, up & downswing and left & right swing;
- Can be switched in auto, cooling, dehumidifying, fan, heating, floor heating, 3D heating, and space heating operation modes;
- Master and slave wired controllers can be set; simultaneous control over several IDUs is available;
- Available functions: sleep, ventilation, quiet/auto quiet, light, energy-saving, auxiliary heating, drying, memory, low-temperature dehumidifying, absence in heating, controllable auxiliary heating in dehumidifying, filter cleaning reminder, etc.;
- Detect ambient temperature; receive infrared remote controller signal;
- With project parameters viewing and setting functions.

## Wired Controller XK79 (For hotel)



- Small and fashionable appearance with a thickness only of 12mm and backlighting LCD with black background and white words;
- Eight touch buttons;
- A clock can be displayed and set in countdown and clock timer;
- Besides normal functions, other functions such as low-temperature dehumidifying, absence in heating, controllable auxiliary heating in dehumidifying and filter cleaning reminder can also be set;
- The door control system can be connected.

## Remote Controller YAP1F



- Can be switched in auto, cooling, dehumidifying, fan and heating operation modes;
- Besides turbo, 6 fan speeds can be set;
- Available functions: child lock, drying, health, ventilation, turbo, sleep, light, absence, I-feel and timer;
- Clock display and indoor/outdoor ambient temperature viewing functions;
- Up & downswing and left & right swing.

## Remote Controller YV1L1



- Backlighting LCD;
- Can be switched in auto, cooling, dehumidifying, fan, heating, floor heating, 3D heating, and space heating operation modes;
- 7 fan speeds, up & downswing and left & right swing;
- Available functions: child lock, energy-saving, drying, health, ventilation, quiet/auto quiet, sleep, light, absence, low-temperature dehumidifying, I-feel and timer;
- With clock display, system parameters viewing and setting functions.



## Wired Controller XK86



- Elegant and concise appearance;
- Touch buttons with backlighting LCD;
- Chinese and English display can be switched;
- With weekly timer function;
- Complete system functions with each function implemented in an individual page;
- Refreshing, auto dehumidifying, absence and other modes can be set;
- Detect ambient temperature precisely;
- With electricity consumption inquiry function (Unit with electricity measurement function shall be connected);
- With service hotline inquiry and after-sales phone number record functions;

## Wired Controller XE70-33/H



- It has a black and white LCD display with backlight function;
- It is equipped with touch buttons, supporting infrared remote signals;
- The display language can switch to Chinese or English;
- Multiple weekly timers can be set at the same time. User can preset mode, temperature and fan speed under weekly timer;
- There are 7 fan speeds, vertical air swing and horizontal air swing;
- It is designed with functions of sleep, ventilation, quiet/auto quiet, light, energy-saving, E-heating, X-fan, memory, low-temp drying, filter cleaning indication; It is with parameter viewing and setting functions;
- It is with service line inquiry and after-sales phone number recording functions;

- **Single control of one unit**

Each indoor unit has an independent controller.



- **Multiple control of one unit**

One indoor unit can be controlled by several wired controllers at different places.



- **Central control of several indoor units**

One wired controller can control as many as 16 indoor units.



- **Joint control of remote controller and wired controller**

Users can control one unit with two types of controllers: a remote controller which is convenient and flexible; or a wired controller which includes every function of an air conditioner.



Single control of one unit  
(Wired controller and remote controller control the unit jointly or separately)



Multiple control of one unit at different places



Central control of several indoor units



# Smart Zone Controller and Central Controller

## Smart Zone Controller CE53-24/F(C)

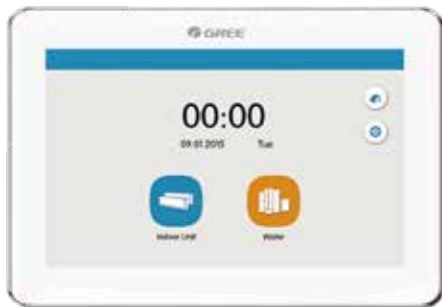

- High-resolution color LCD;
- 7" capacitive touch screen for easy operation;
- Shielding function of a single unit, group and all IDUs (shielding on/off, mode, temp setting, etc.);

- With various functions: centralized control(control all indoor units), group management(support DIY grouping), schedule management(setting of several schedules) and single-unit control(on/off, mode, temp setting, fan speed, quiet, swing control, etc.);
- Provide naming of indoor units, selection of icons and personalized settings(setting background, backlight, etc);
- Up to 32 units can be centrally controlled;
- Elegant and fashionable appearance;
- Embedded installation in a wall with projecting thickness only of 11mm;
- Connectable with a network of indoor units or outdoor units;
- The Independent power supply in 100~240V wide voltage range;
- With project setting, parameter viewing, malfunction record and access management functions.

## Central controller CE52-24/F(C)



- High-resolution color LCD;
- 7" capacitive touch screen for easy operation;
- With project setting, parameter viewing, malfunction record and access management functions.

- With various functions: centralized control(control all indoor units), group management(support DIY grouping), schedule management(setting of several schedules) and single-unit control(on/off, mode, temp setting, fan speed, quiet, swing control, etc.);
- Shielding function of a single unit, group and all IDUs (shielding on/off, mode, temp setting, etc.);
- Provide naming of indoor units, selection of icons and personalized settings(setting background, backlight, etc);
- Up to 255 units can be centrally controlled;
- Elegant and fashionable appearance;
- Embedded installation in a wall with projecting thickness only of 11mm;
- Connectable with a network of indoor units or outdoor units;

## E-smart Zone Controller CE54-24/F(C)



- An indoor or outdoor unit network can be connected, simple and flexible;
- 100~240V super wide voltage for independent power supply, stable and reliable;
- With functions of engineering setting, parameters view, malfunction view and authority management, easy for debugging and maintenance.

- Adopt built-in type installation; the exposed part is only 11mm;
- High-resolution colorful LCD;
- 4.3-inch capacitive touch screen for easy operation;
- With single indoor unit control(including general functions and advanced functions), group indoor units control(including general functions and advanced functions), group management(supporting DIY group), single indoor unit and group indoor units timer functions;(general function: ON/OFF, Mode, Set, Fan, Swing, etc; advance functions: Save, Sleep, E-heater, Absence, Quiet, Turbo, etc)
- With long-distance shield function (shield switch, mode, set, etc) for a single unit, group and all indoor units;
- Support denomination for indoor units, and icon selection, realizing individuation management; Support maximum of 32 indoor units, with powerful function;

# Smart Zone Controller and Central Controller

## Power Generation & Consumption Management Central Controller CE55-24/F(C)



- The air conditioning central control also provides shielding functions (on/off shield, mode shield, temperature shield, etc.) for a single unit, a group of units and all the indoor units. Remote shield is available. When the shield function is enabled, the wired controller and remote controller of indoor unit will be locked, and only the Power Generation & Consumption Management Central Controller is allowed to be used;
- Directly connected to the network of indoor units; no extra communication module is needed, it is more flexible and convenient;
- Super wide voltage range from 100V to 240V; independent power supply, stable and reliable.











- It is white in color, with a round frame. There is only one tangible button on the controller;
- Embedded type installation: The outer part is only 11mm thick;
- The 7-inch super large capacitor type touch screen has a resolution of 1280\*800, clear display, fine images and vivid colors;
- The software operating interface is user-friendly and easy to use. It adopts full touch control, which is very convenient;
- Its two main functions: PV power generation and consumption data management, central control of air conditioning;
- In terms of power generation and consumption management, it provides parameter query (real-time data display of photovoltaic power generation, unit power consumption, grid power supply), power calculation (monthly and yearly calculation), power curve (such as real-time), and power generation and consumption dynamic display;
- Regarding the central control of air conditioning, it provides multiple control modes, including central control (overall air conditioning), group management (supports user-defined group management), schedule management (settings for different schedules, such as holidays), and single-unit control (Power on / off, mode selection, temperature setting, fan speed adjustment, sound adjustment, air volume setting, etc.);
- Support indoor unit naming, icon selection and personalized settings of the central controller (background setting, sound setting, etc.);
- Can Connect up to 16 sets of PV Direct-driven Inverter Multi VRF Systems, and can use up to 128 air conditioning units;

## 24V Converter ME32-33/H



- Simple appearance, moisture-proof structure;
- Various interfaces: 1 set of third-party controller signal interfaces and 4 sets of dry contact signal interfaces;
- Signal conversion of a third-party controller: convert the control signal of 24VAC HVAC Thermostat into the control signal of GMV5. In this way, a third-party controller like 24VAC HVAC Thermostat can control our GMV5 units;
- Fire alarm and other dry contact signal detection: it is used to detect fire, external water tray overflow, etc. so as to shut down the air conditioner in time to protect property and people.

# Control System Lineup

Controlling systems		Outdoor series		GMV5	GMV5 MINI	GMV5 HR	Water-cooled GMV5	GMV5 Solar
Long-distance monitor	Intelligent Remote Eudemon	FE30-24/DF(B)		○	○	○		
		ME30-24/DF(B)						
	Gateway of Building Protocol	ME30-24/E5(M)		○	○	○	○	
		ME30-24/E6(M)		○	○	○	○	
		ME30-24/D4(B)		○	○	○	○	
	Intelligent Billing Eudemon	FE11-24/D4(B)		○	○	○		
GBM-LCG100E								
LTE_DTU	IE60-33/CF2		○	○		○	○	
G-Cloud	ME31-00/C7		○	○	○			
Other modules	Optoelectronic Isolated Converter	GD02		○	○	○		
	Optoelectronic Isolated Signal Multiplier	RS485-W		○	○	○		
	Portable Commissioning Tool	CE41-24/F(C)		○	○	○	○	○
	Dry Contact & 24V Adaptor	ME32-33/H		○	○	○	○	○

Controlling system		Indoor series		Cassette Type	(High ESP, Low ESP, Slim Ducted) Duct Type	Fresh Air Processing	Wall mounted Type	Floor Ceiling Type	Console Type	Floor Standing Type	Air Handler
Remote Controller	YAP1F		●	○	○	●	●	●	●	●	○
	YV1L1		○	○	○	○	○	○	○	○	○
Wired Controller	XK46		○	●	●	○	○	○	○	○	●
	XK79		○	○	○	○	○	○	○	○	○
	XK86		○	○	○	○	○	○	○	○	○
	JS05(receiver)			○	○						
	XE70-33/H		○	○	○	○	○	○	○	○	○
Centralized Controller	CE52-24/F(C)		○	○	○	○	○	○	○	○	○
	CE55-24/F(C)		○	○	○	○	○	○	○	○	○
Smart Zone Controller	CE53-24/F(C)		○	○	○	○	○	○	○	○	○
E-Smart Zone Controller	CE54-24/F(C)		○	○	○	○	○	○	○	○	○

Note: ● means standard, ○ means optional.



## Branching Joint (For GMV5 units)

### For Indoor & Outdoor Units

Model	Total Capacity X(Btu/h)	Appearance	
		Gas Pipe	Liquid Pipe
FQ01A/A	$X < 68,000$		
FQ01B/A	$68,000 \leq X \leq 102,000$		
FQ02/A	$102,000 < X \leq 239,000$		
FQ03/A	$239,000 < X \leq 460,600$		
FQ04/A	$460,600 < X$		

Note: Above dimensions are engineering piping dimensions.

### For Outdoor Units

Model	Appearance	
	Gas Pipe	Liquid Pipe
ML01/A		

Note: Above dimensions are engineering piping dimensions.

## Branching Joint (For GMV5 units)

### For Indoor Units

Model	Sort	blueprint
FQ14/H1	Liquid pipe	
	Gas pipe	
FQ18/H1	Liquid pipe	
	Gas pipe	
FQ18/H2	Liquid pipe	

Note: Above dimensions are engineering piping dimensions.

Total rated capacity of downstream indoor units X(Btu/h)	Upstream connection pipe dimension		Model of manifold pipe
	Gas pipe (inch)	Liquid pipe (inch)	
$X \leq 136,000$	$\leq \Phi 1$	$\leq \Phi 1/2$	FQ14/H1
$136,000 < X \leq 232,000$	$\leq \Phi 1-1/8$	$\leq \Phi 5/8$	FQ18/H1
$232,000 < X$	$\geq 1-1/4$	$\geq 3/4$	FQ18/H2

## Branching Joint (For GMV5 HR)

### For Outdoor Units and Mode Exchanger

Model	Total capacity of the downstream indoor unit X(Btu/h)	Appearance		
		High-pressure gas pipe	Low-pressure gas pipe	Liquid pipe
FQ01Na/A	$X \leq 17,100$			
FQ02Na/A	$17,100 < X \leq 76,400$			
FQ03Na/A	$76,400 < X \leq 95,500$			
FQ04Na/A	$95,500 < X \leq 232,000$			
FQ05Na/A	$232,000 < X \leq 327,500$			
FQ06Na/A	$327,500 < X \leq 460,600$			
FQ07Na/A	$460,600 < X$			

Note: Above dimensions are engineering piping dimensions.

### For Indoor & Mode Exchanger

Model	Total capacity of the downstream indoor units X(Btu/h)	Appearance	
		Gas Pipe	Liquid Pipe
FQ01A/A	$X < 68,000$		
FQ01B/A	$68,000 \leq X \leq 102,000$		

Note: Above dimensions are engineering piping dimensions.

### For Outdoor Units

Model	Module's capacity X(Btu/h)	Appearance		
		High-pressure gas pipe	Low-pressure gas pipe	Liquid pipe
ML01R	$X \leq 327,500$			
ML02R	$327,500 < X$			

Note: Above dimensions are engineering piping dimensions.

Branching Joint ( For AHU KIT)

Model	Appearance
	Liquid Pipe
FQ01U/A	

Note: Above dimensions are engineering piping dimensions.

Reducer/expander pipe dimensions

Note: Above dimensions are engineering piping dimensions.